

龍潭元勝股份有限公司

V-1

ASCENT Architectural Material Limited

GRC玄關

桃園縣龍潭鄉文化路571號 TEL: (03) 471-3991 FAX: (03) 471-3982

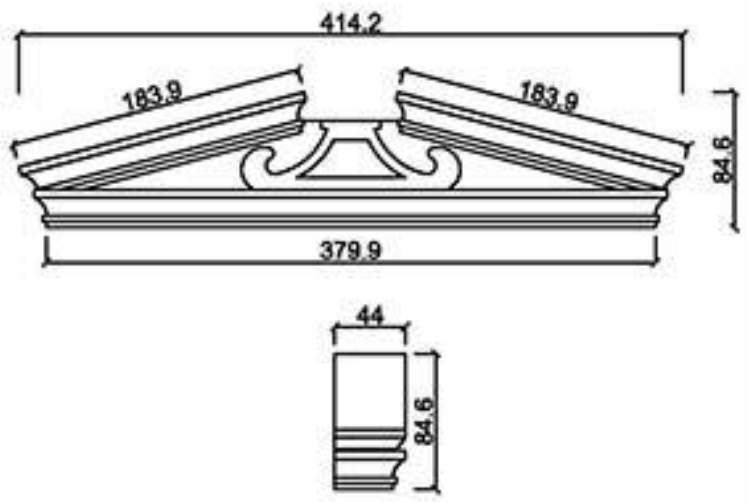
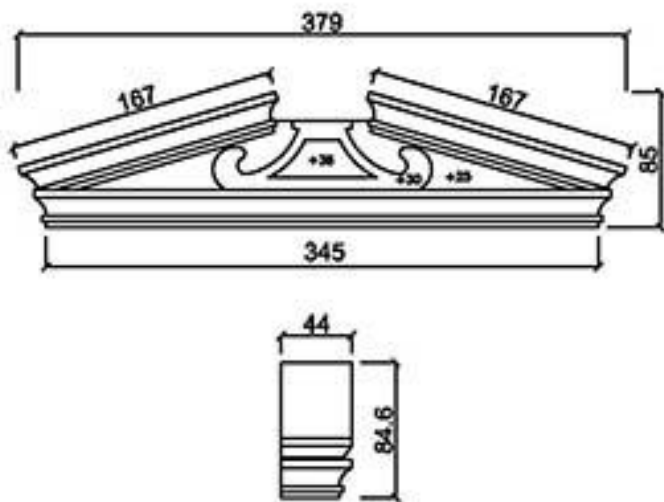

型號 V-85379

型號 V-85414

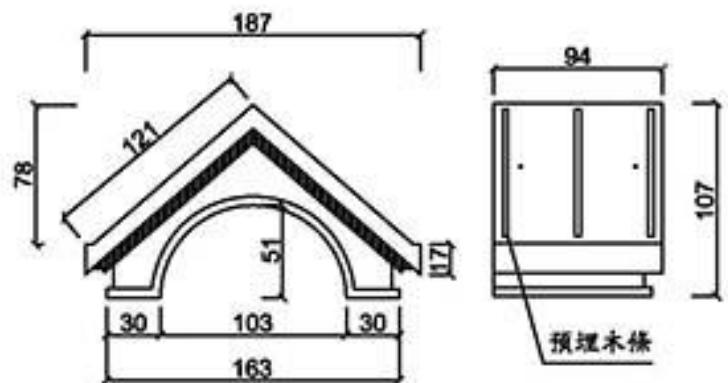
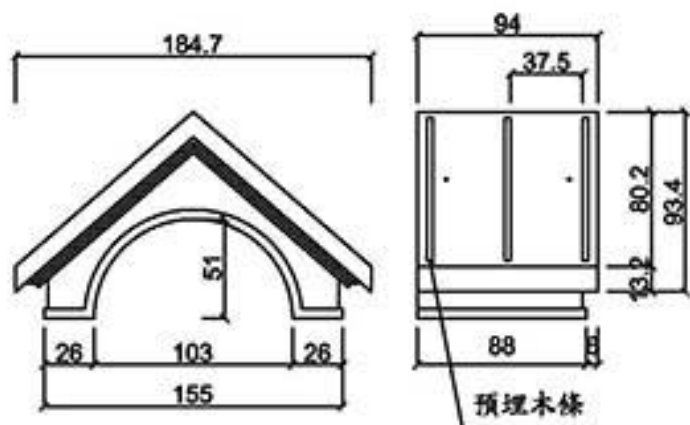

型號 V-107185

型號 V-107187

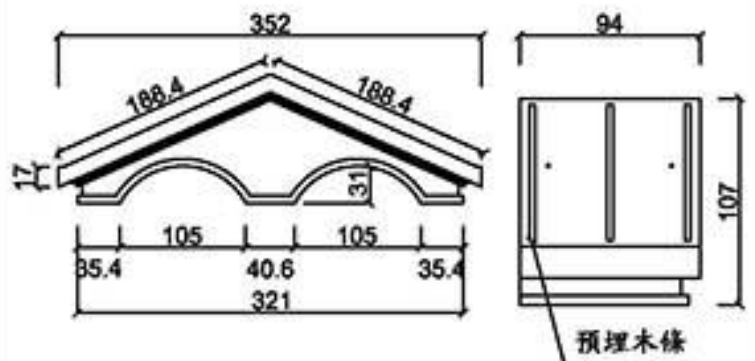
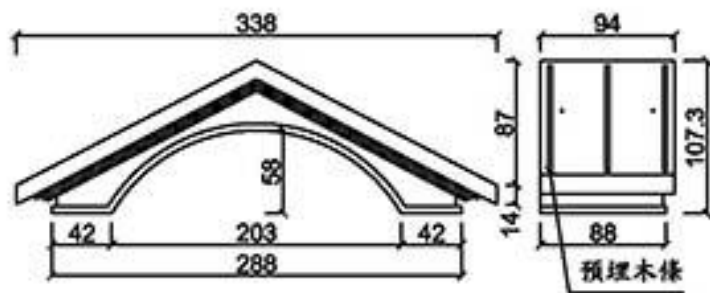

型號 V-107338

型號 V-107352

龍潭元勝股份有限公司

V-2

ASCENT Architectural Material Limited

GRC玄關

桃園縣龍潭鄉文化路571號 TEL: (03) 471-3991 FAX: (03) 471-3982

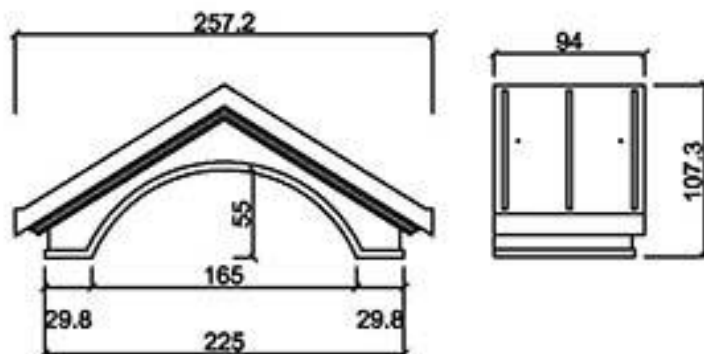
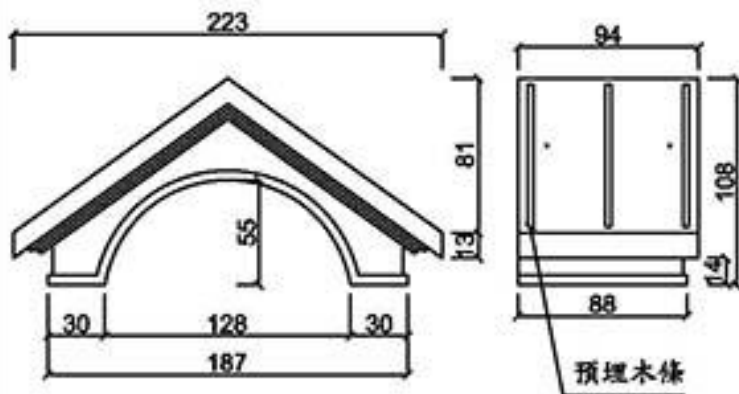

型號

V-108223

型號

V-108258

型號

型號

型號

型號

龍潭元勝股份有限公司

WB-3

ASCENT Architectural Material Limited

GRC溝槽版

桃園縣龍潭鄉文化路571號 TEL: (03) 471-3991 FAX: (03) 471-3982

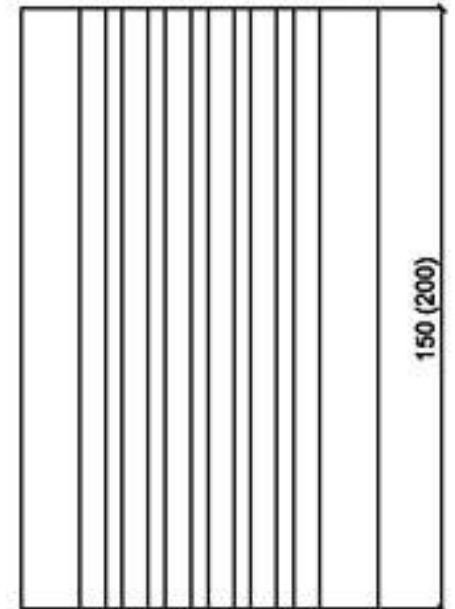
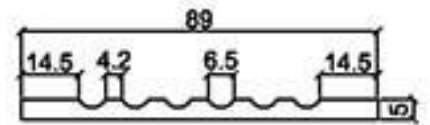
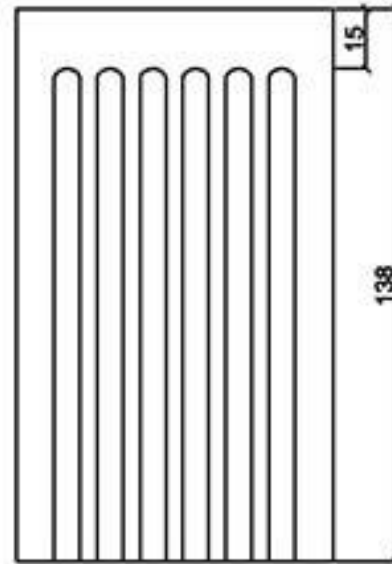
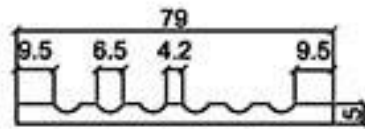
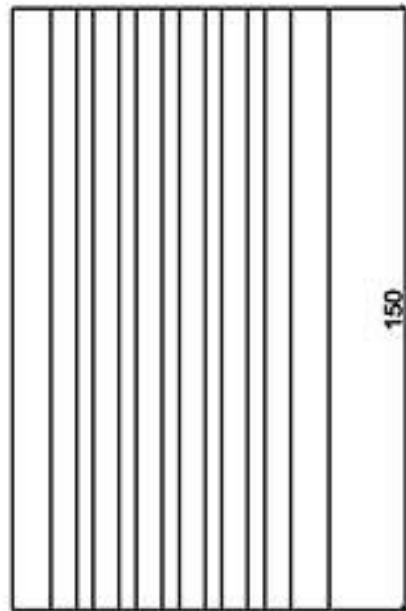
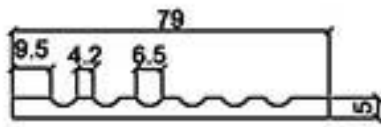

型號 WB-0579

型號 WB-0579A

型號 WB-0589

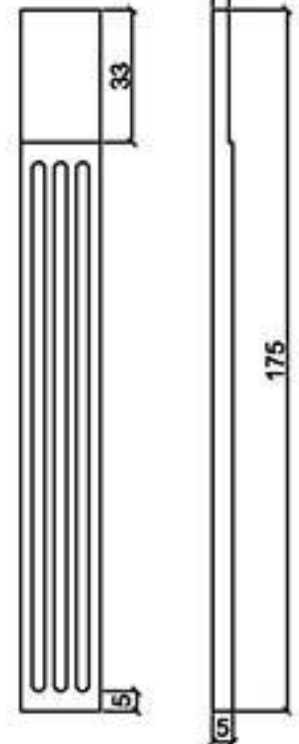
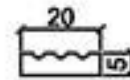
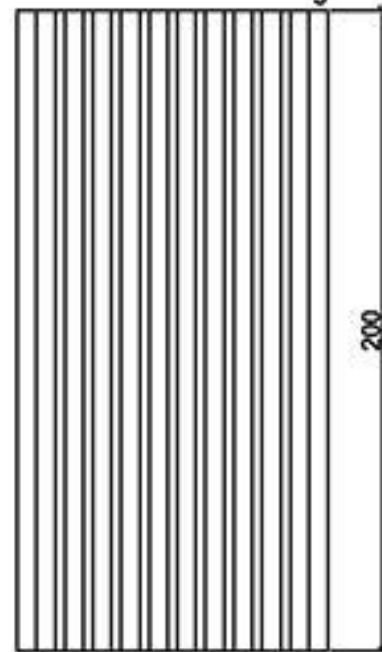
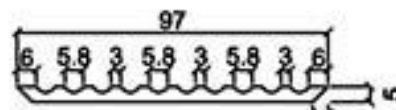
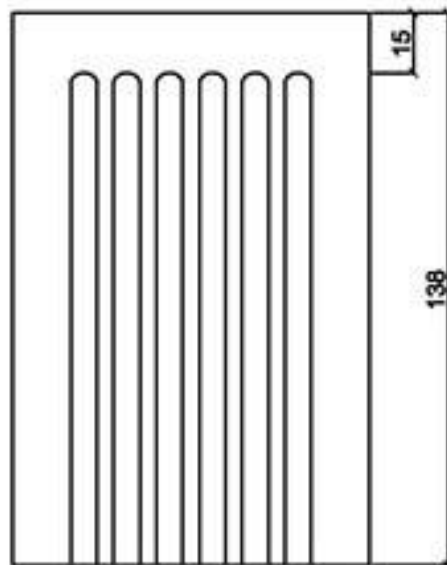
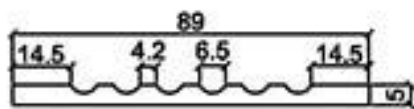

型號 WB-0589A

型號 WB-0597

型號 WB-05175

龍潭元勝股份有限公司

WB-4

ASCENT Architectural Material Limited

GRC溝槽版

桃園縣龍潭鄉文化路571號 TEL: (03) 471-3991 FAX: (03) 471-3982



型號 WB-05192

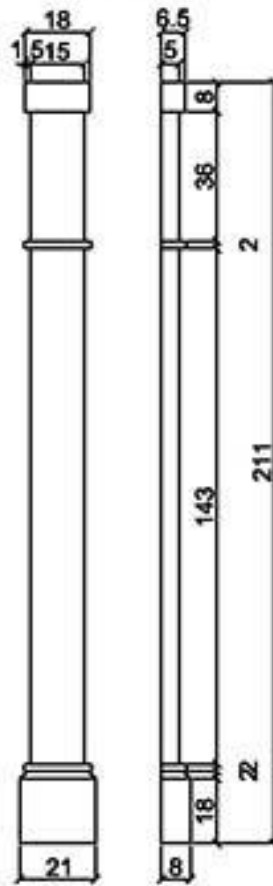

型號 WB-05211

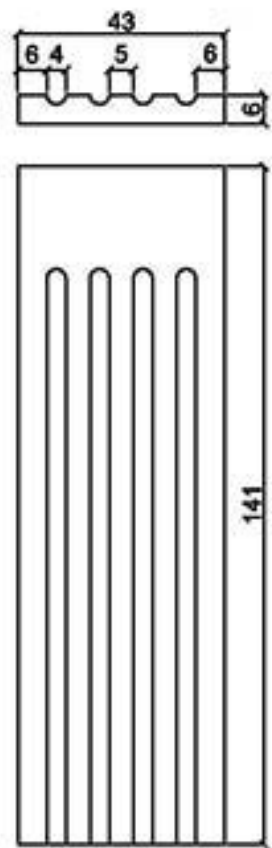

型號 WB-0643A



型號 WB-0643B

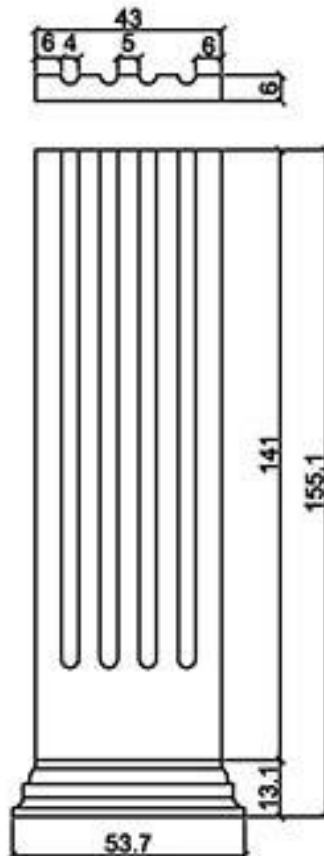

型號 WB-0643C

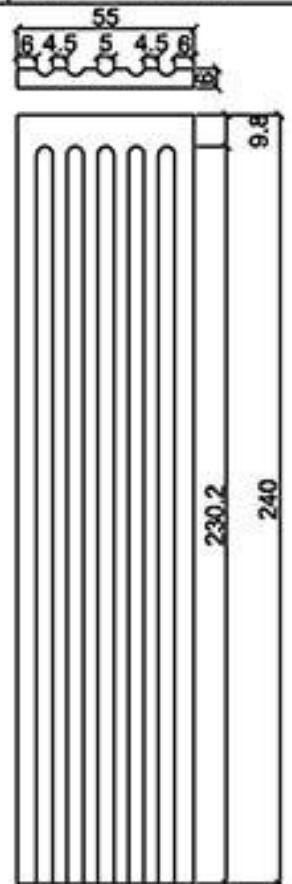

型號 WB-0655

龍潭元勝股份有限公司

WB-5

ASCENT Architectural Material Limited

GRC溝槽版

桃園縣龍潭鄉文化路571號 TEL: (03) 471-3991 FAX: (03) 471-3982



型號 WB-06150



型號 WB-06225



型號 WB-06295

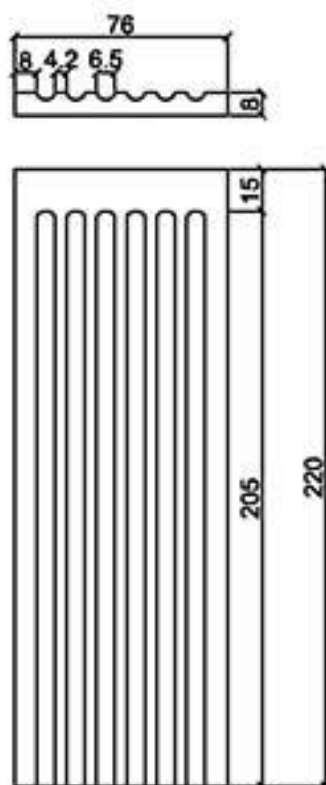

型號 WB-0876A



型號 WB-0876B

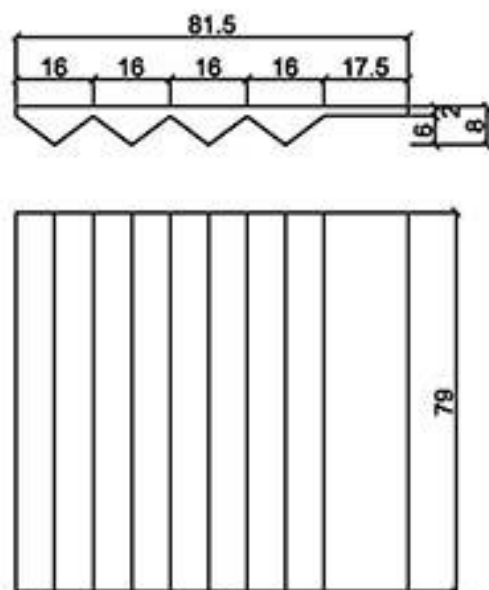

型號 WB-0879-82

龍潭元勝股份有限公司

WB-6

ASCENT Architectural Material Limited

GRC溝槽版

桃園縣龍潭鄉文化路571號 TEL: (03) 471-3991 FAX: (03) 471-3982

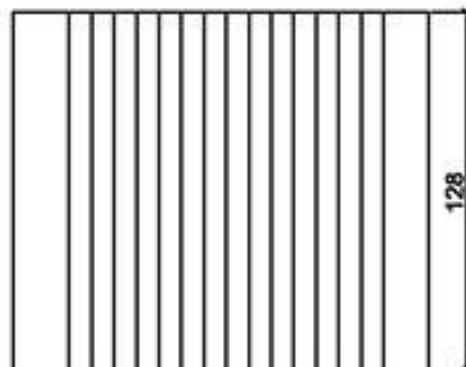
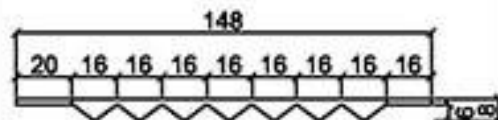
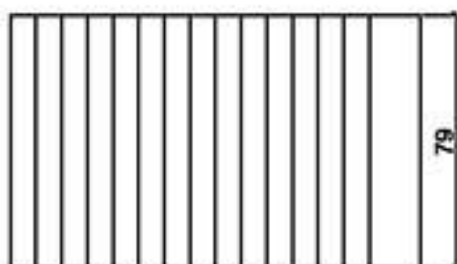
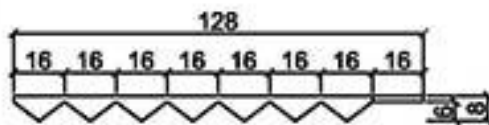
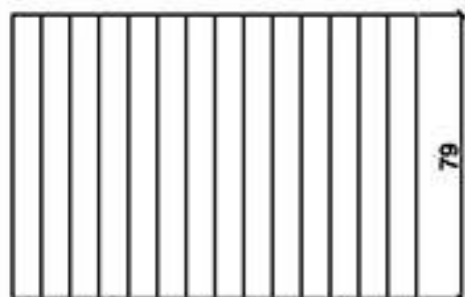
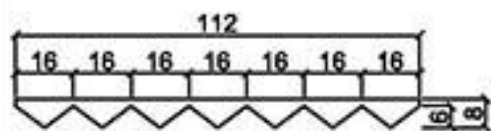

型號 WB-0879-112

型號 WB-0879-128

型號 WB-08128

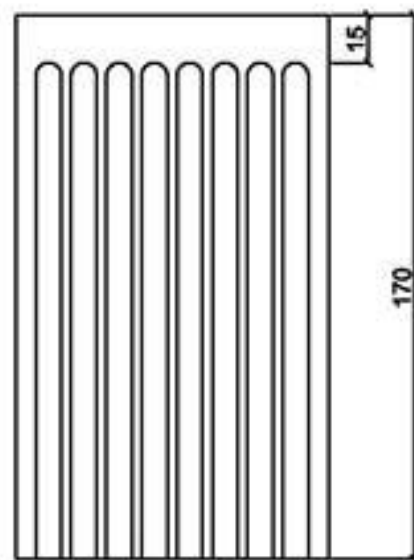
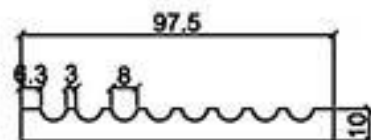
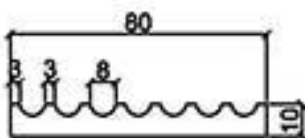
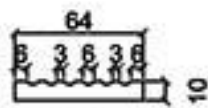

型號 WB-1064

型號 WB-1080A

型號 WB-1098A

龍潭元勝股份有限公司

WB-7

ASCENT Architectural Material Limited

GRC溝槽版

桃園縣龍潭鄉文化路571號

TEL: (03) 471-3991

FAX: (03) 471-3982

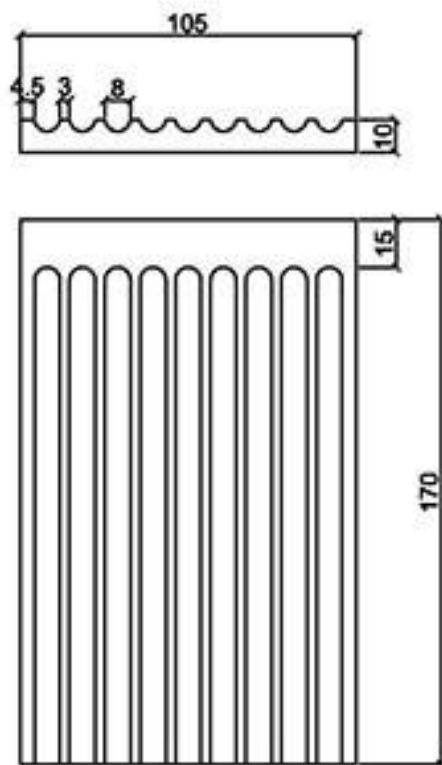

型號 WB-10105A



型號 WB-10148



型號 WB-10192

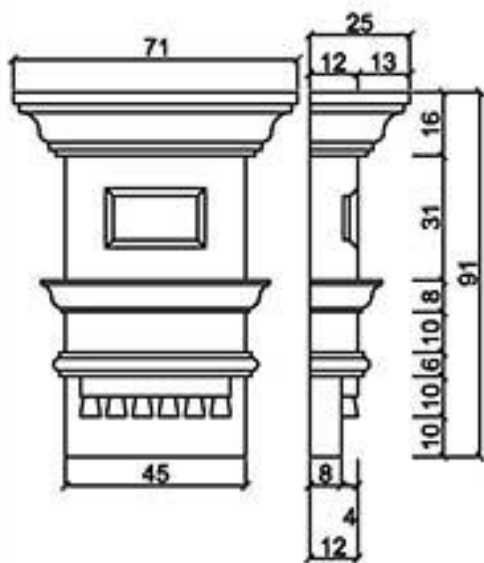

型號 WB-1291

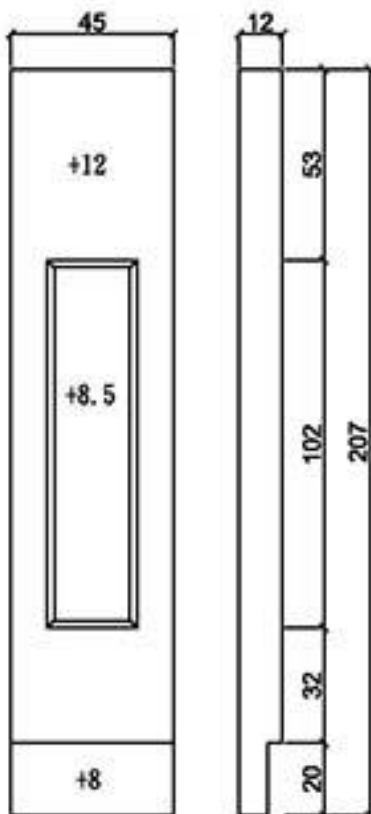

型號 WB-12207

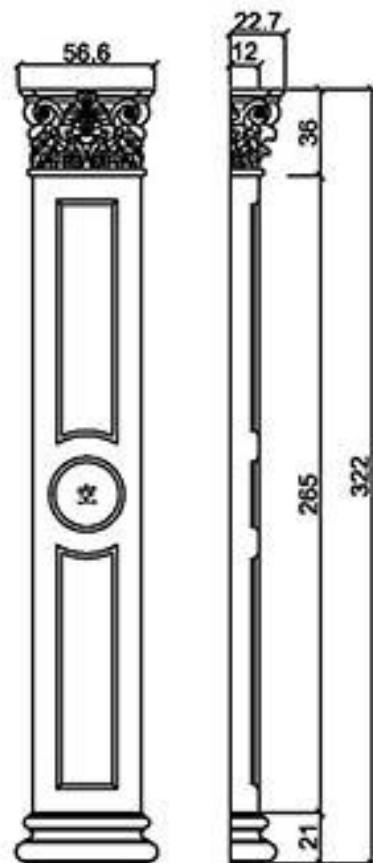

型號 WB-12322

龍潭元勝股份有限公司

WB-8

ASCENT Architectural Material Limited

GRC溝槽版

桃園縣龍潭鄉文化路571號 TEL: (03) 471-3991 FAX: (03) 471-3982

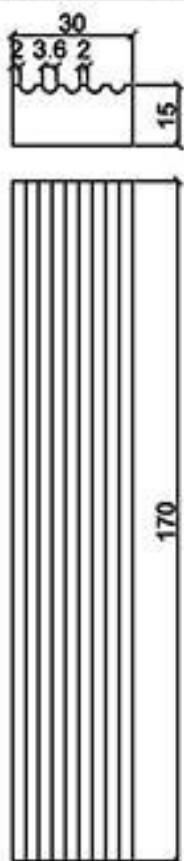

型號 WB-1530



型號 WB-1530A

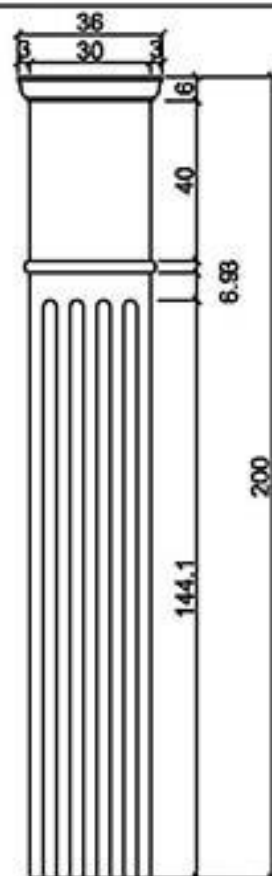

型號 WB-1530B

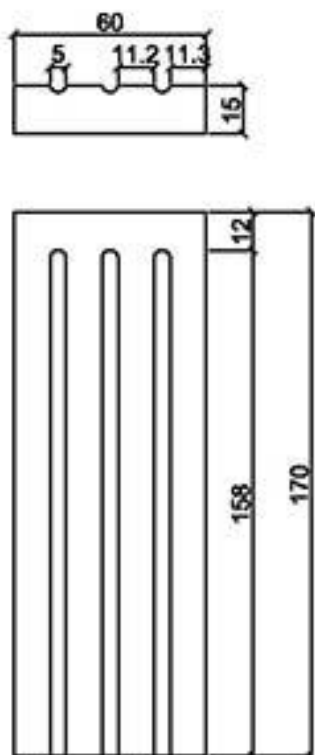

型號 WB-1560A

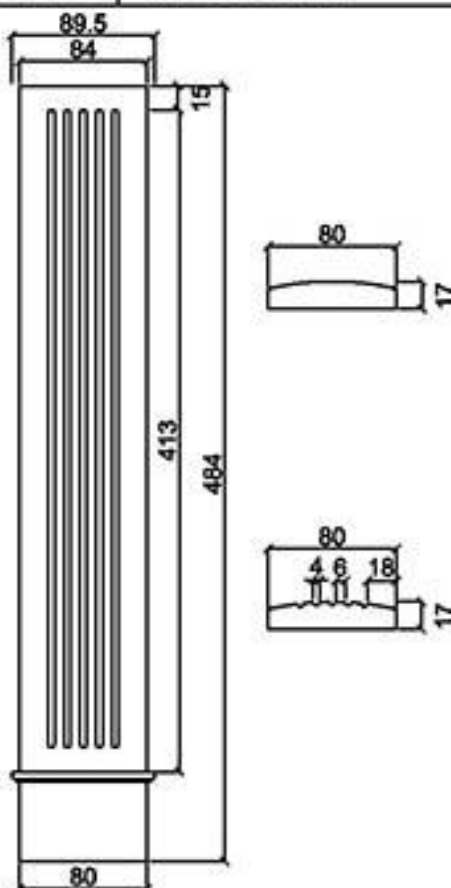

型號 WB-1780

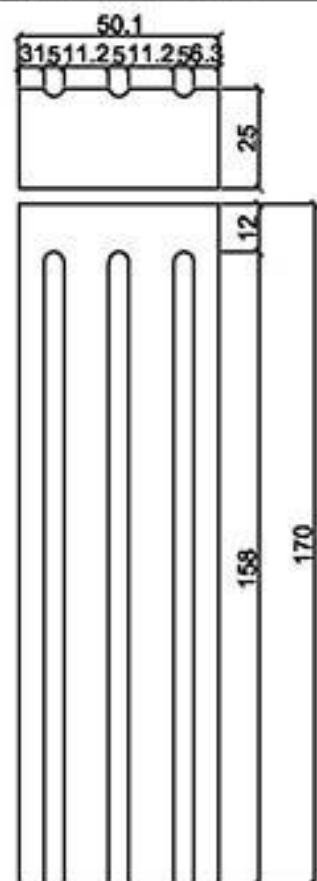

型號 WB-2550A

龍潭元勝股份有限公司

WB-9

ASCENT Architectural Material Limited

GRC溝槽版

桃園縣龍潭鄉文化路571號 TEL: (03) 471-3991 FAX: (03) 471-3982

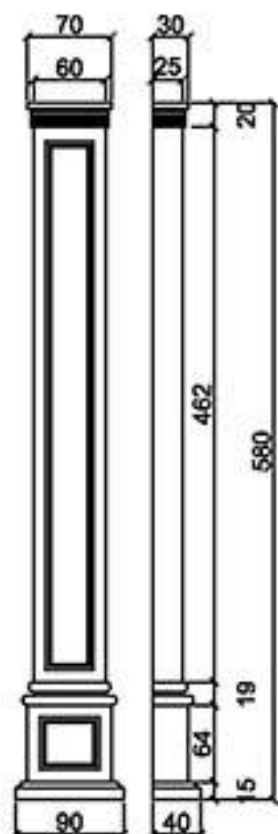

型號 WB-2560

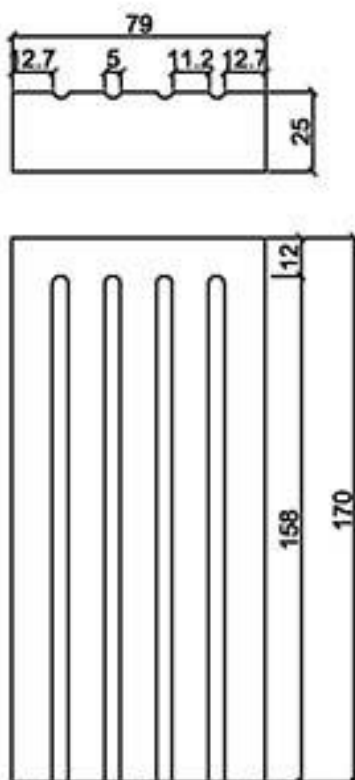

型號 WB-2579A

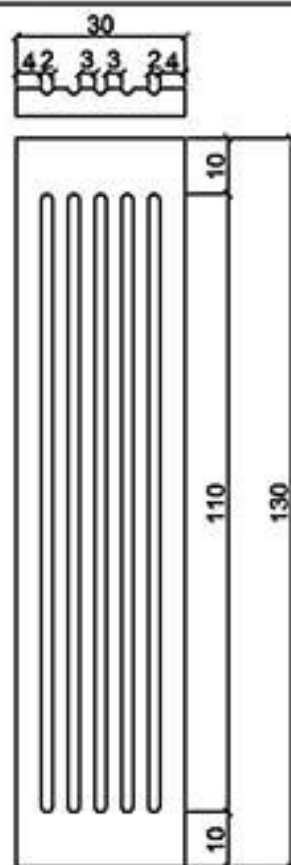

型號 WB-30130

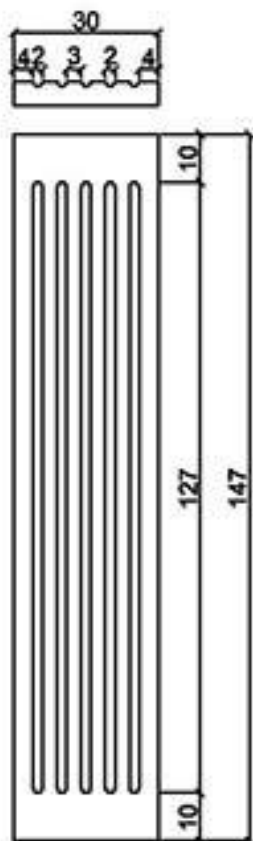

型號 WB-30147



型號 WB-30200

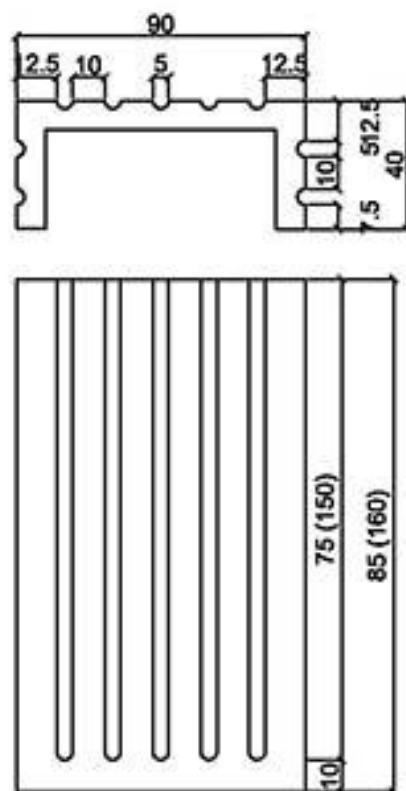

型號 WB-4090

龍潭元勝股份有限公司

WB-10

ASCENT Architectural Material Limited

GRC溝槽版

桃園縣龍潭鄉文化路571號 TEL: (03) 471-3991 FAX: (03) 471-3982

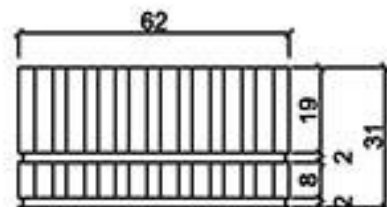
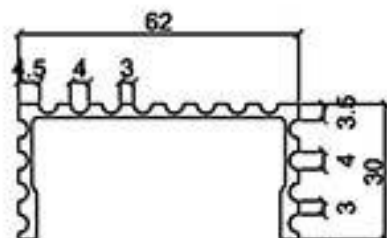
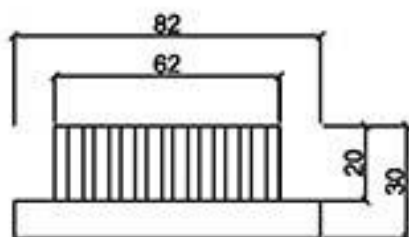
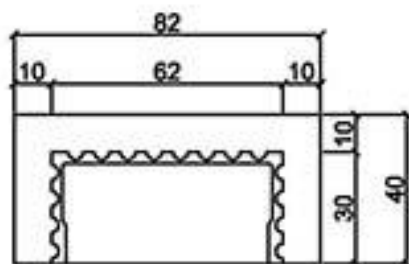
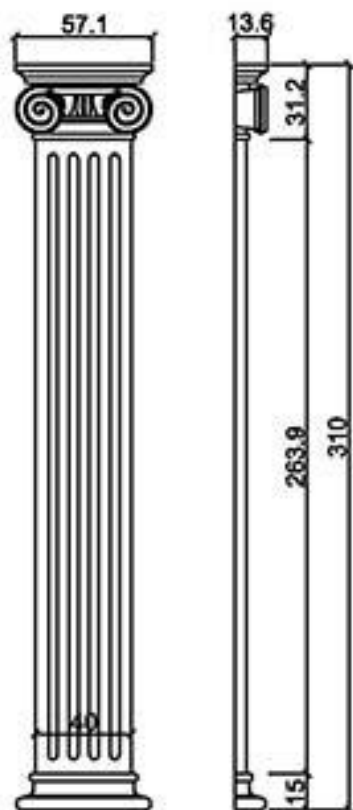

型號 WB-40310

型號 WB-6230

型號 WB-6231

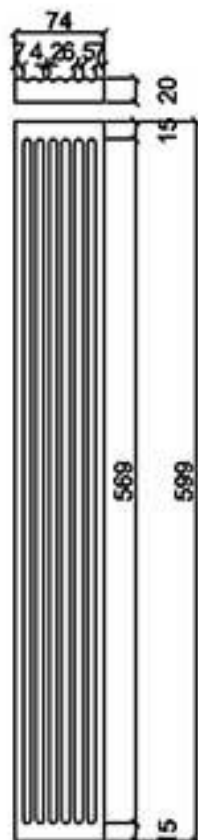
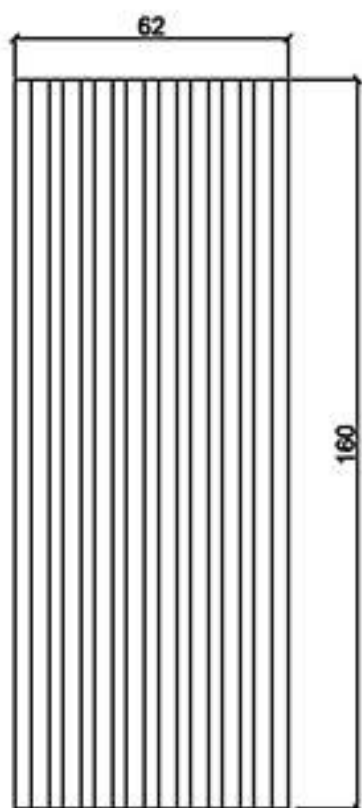

型號 WB-62160

型號 WB-74599

型號

龍潭元勝股份有限公司

WL-1

ASCENT Architectural Material Limited

GRC窗台線版 桃園縣龍潭鄉文化路571號 TEL: (03) 471-3991 FAX: (03) 471-3982

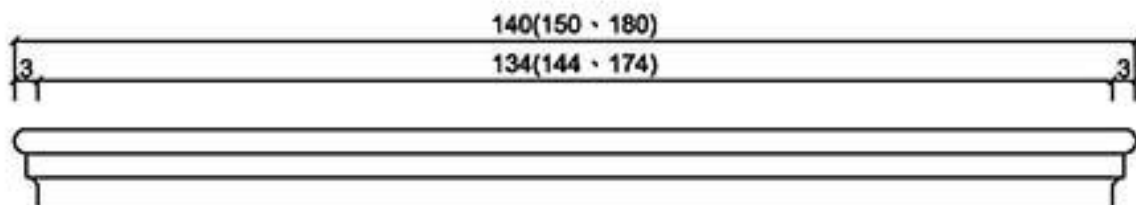

型號

WL-0510A-140(150、180)

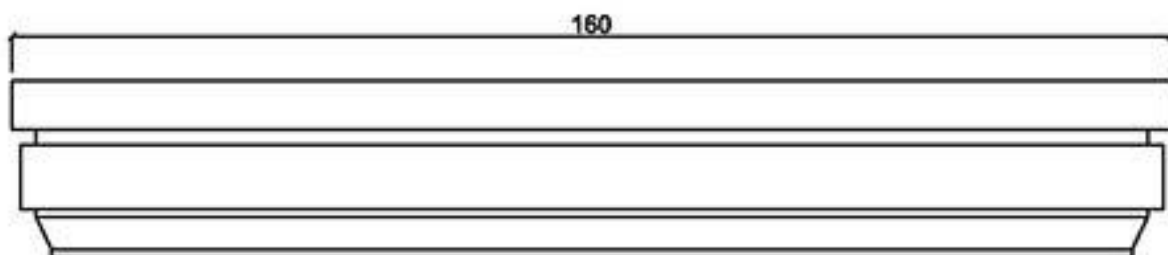
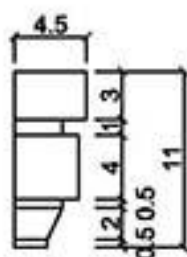

型號

WL-0511-160

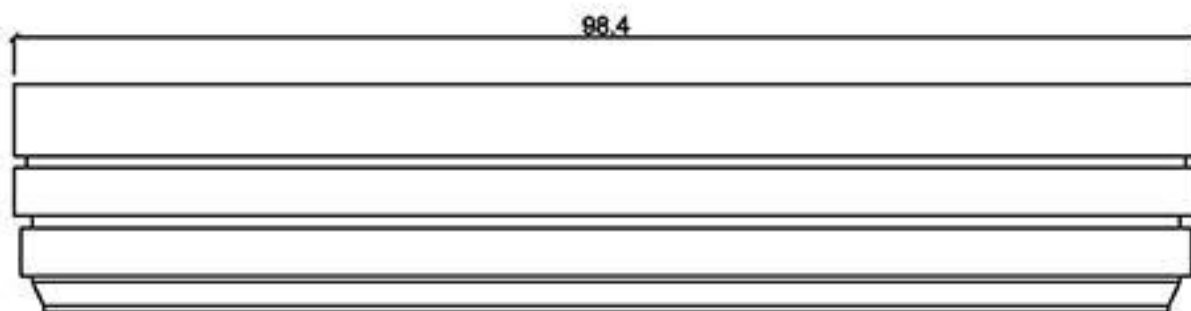
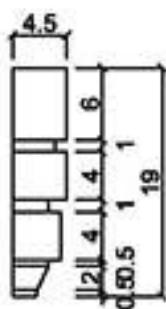

型號

WL-0519-160

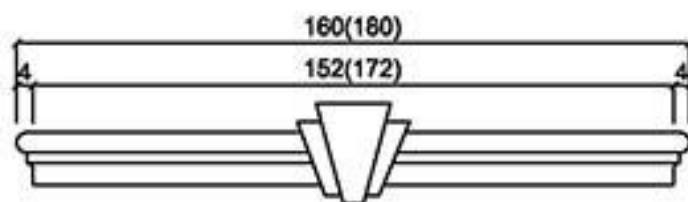
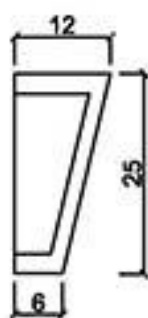
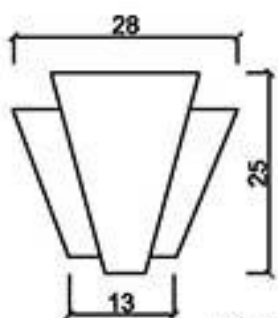

DH-1225

型號

WL-0613-160(180)

龍潭元勝股份有限公司

WL-2

ASCENT Architectural Material Limited

GRC窗台線版 桃園縣龍潭鄉文化路571號 TEL: (03) 471-3991 FAX: (03) 471-3982

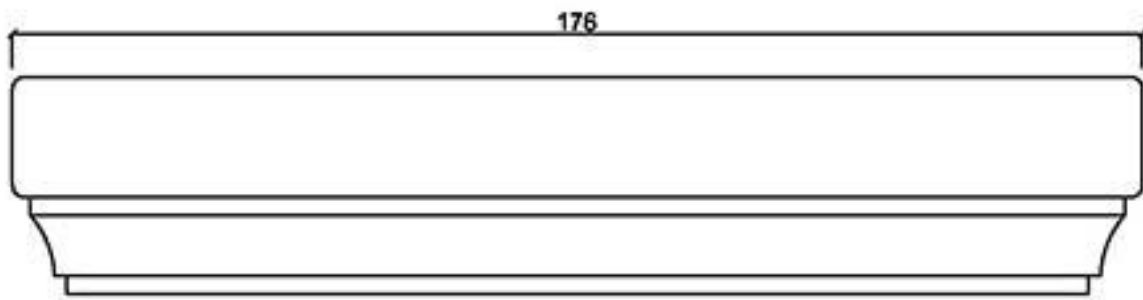
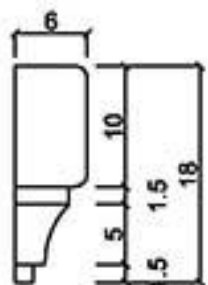

型號

WL-0618-176

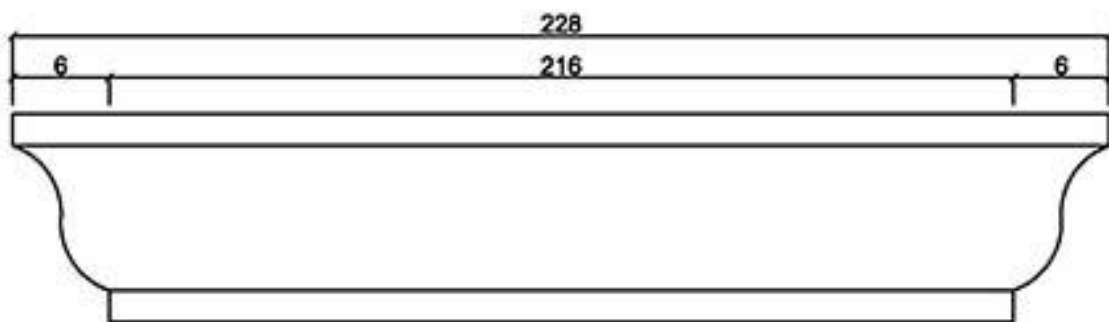
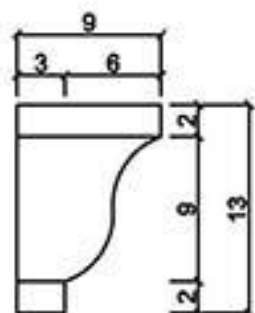

型號

WL-0913-228

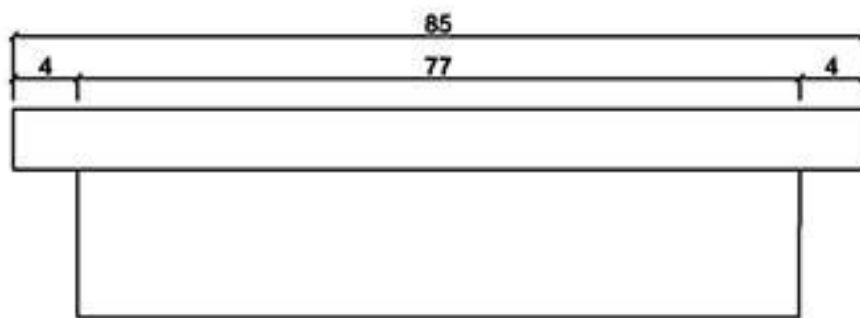
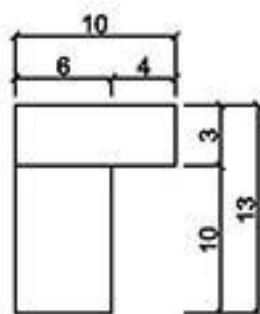

型號

WL-1013-85

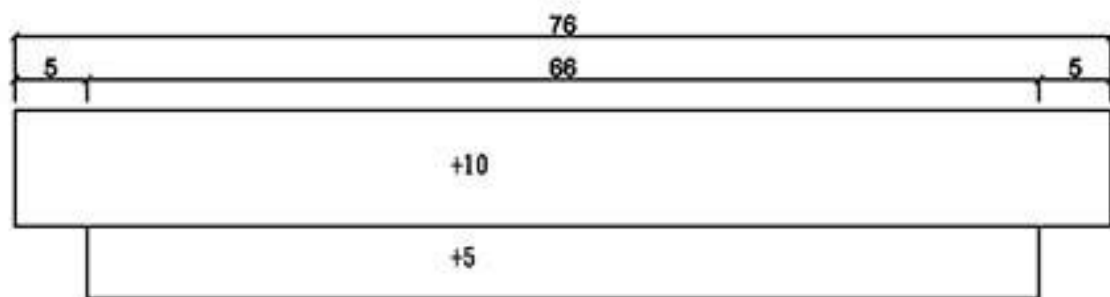
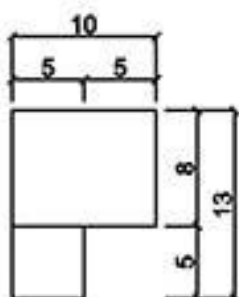

型號

WL-1013A-76

龍潭元勝股份有限公司

WL-3

ASCENT Architectural Material Limited

GRC窗台線版 桃園縣龍潭鄉文化路571號 TEL: (03) 471-3991 FAX: (03) 471-3982

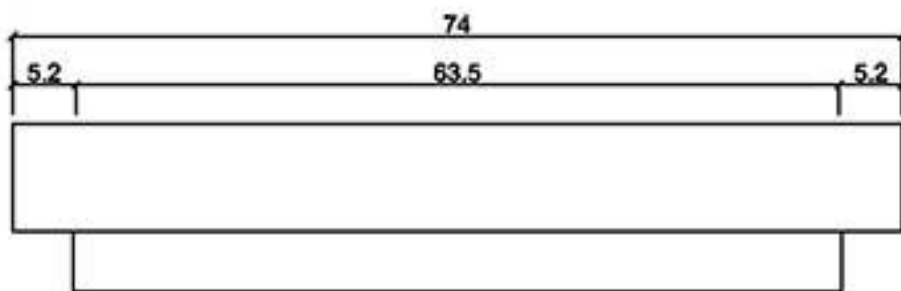
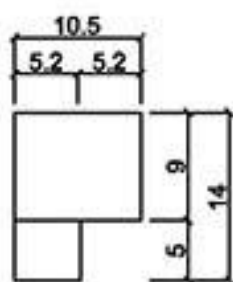

型號

WL-1014-74

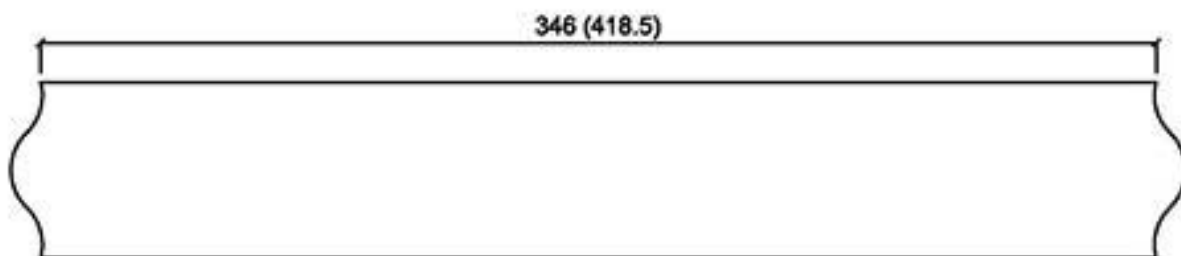
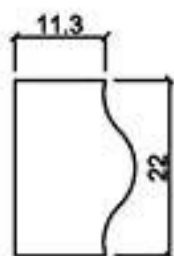

型號

WL-1122A-346(418.5)

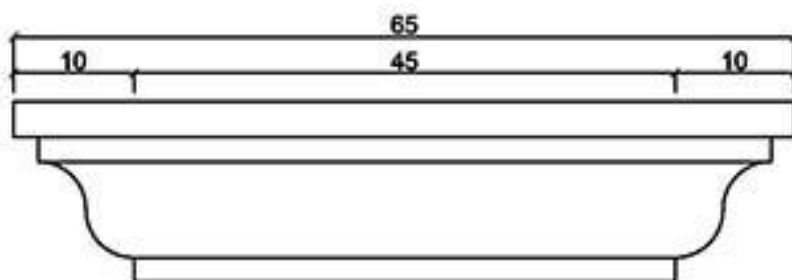
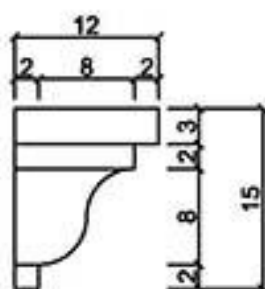

型號

WL-1215A-65

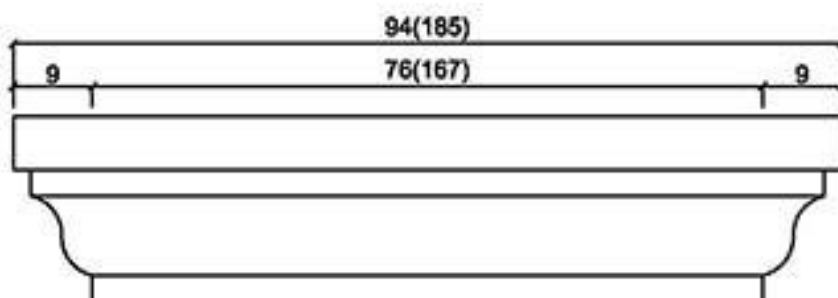
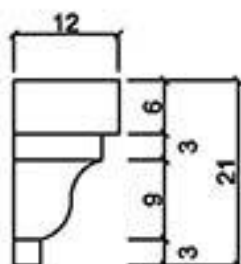

型號

WL-1221-94(185)

龍潭元勝股份有限公司

WL-4

ASCENT Architectural Material Limited

GRC窗台線版 桃園縣龍潭鄉文化路571號 TEL: (03) 471-3991 FAX: (03) 471-3982

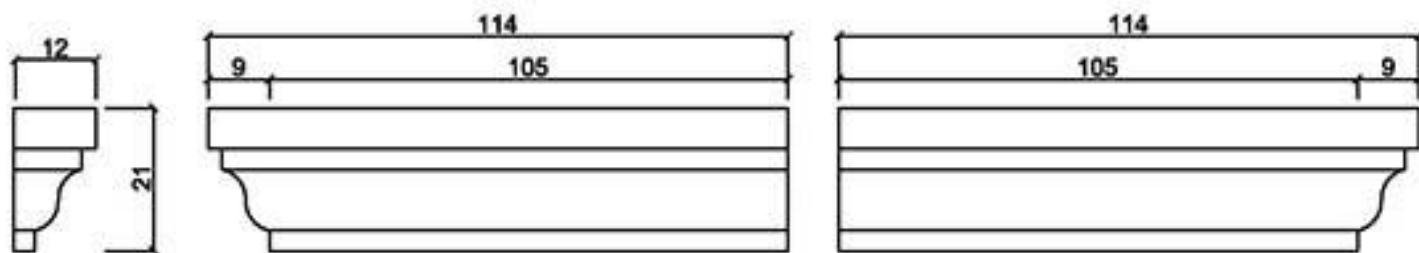

型號

WL-1221R/L

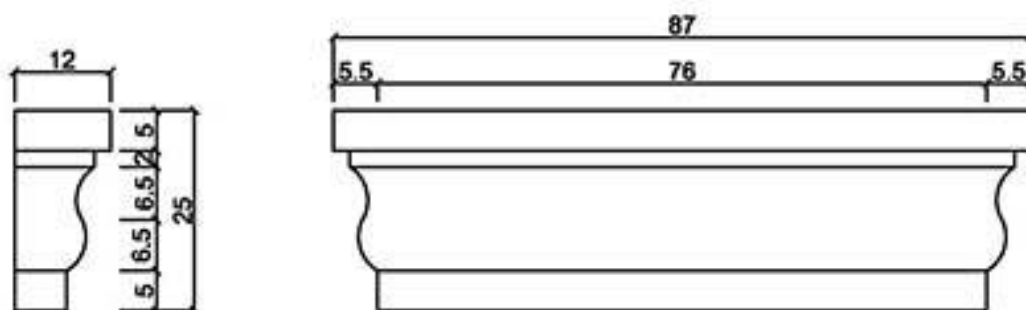

型號

WL-1225

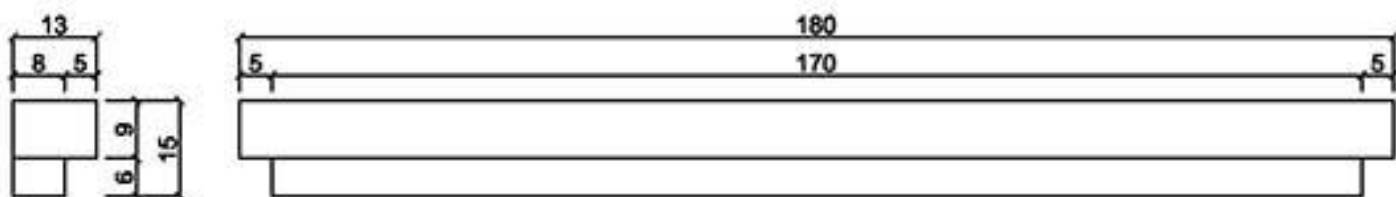

型號

WL-1315-180

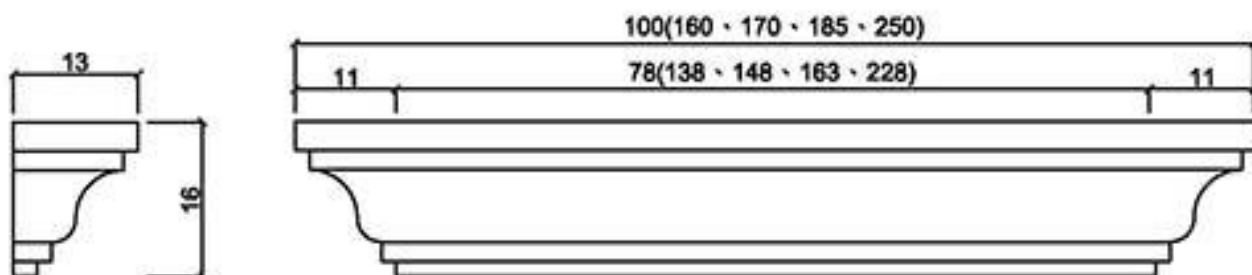

型號

WL-1316-100(160、170、185、250)

龍潭元勝股份有限公司

WL-5

ASCENT Architectural Material Limited

GRC窗台線版 桃園縣龍潭鄉文化路571號 TEL: (03) 471-3991 FAX: (03) 471-3982

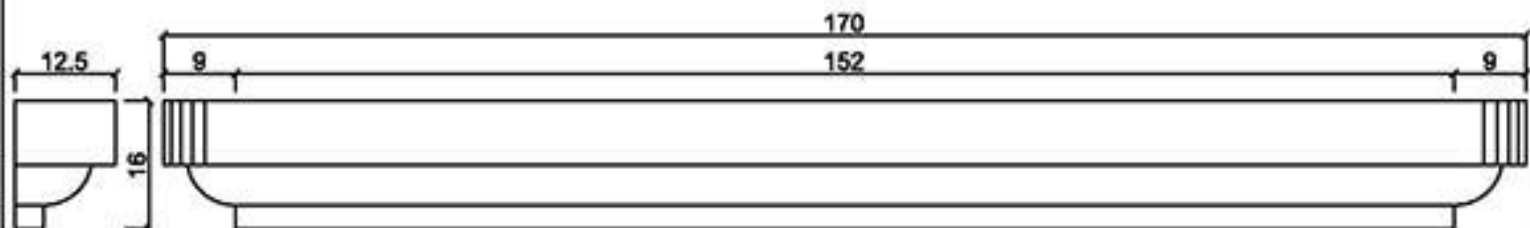

型號

WL-1316A-170



型號

WL-1317-45

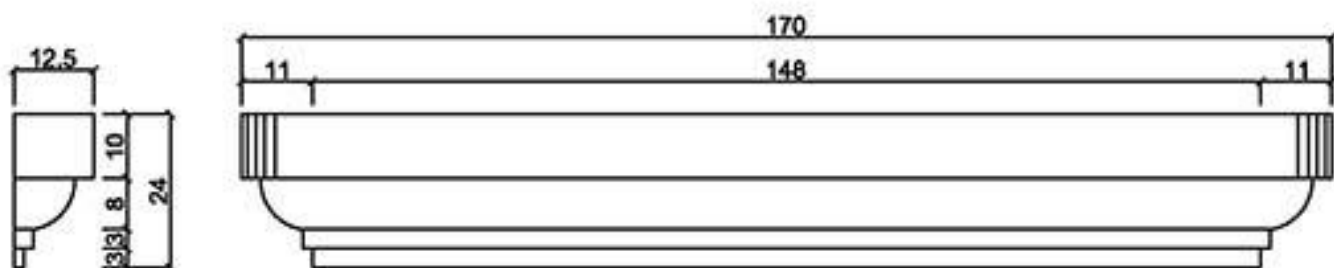

型號

WL-1324-170

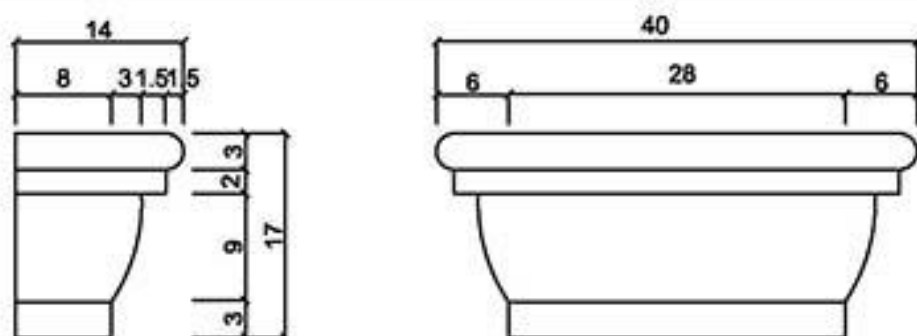

型號

WL-1417-28(40)

龍潭元勝股份有限公司

WL-6

ASCENT Architectural Material Limited

GRC窗台線版 桃園縣龍潭鄉文化路571號 TEL: (03) 471-3991 FAX: (03) 471-3982

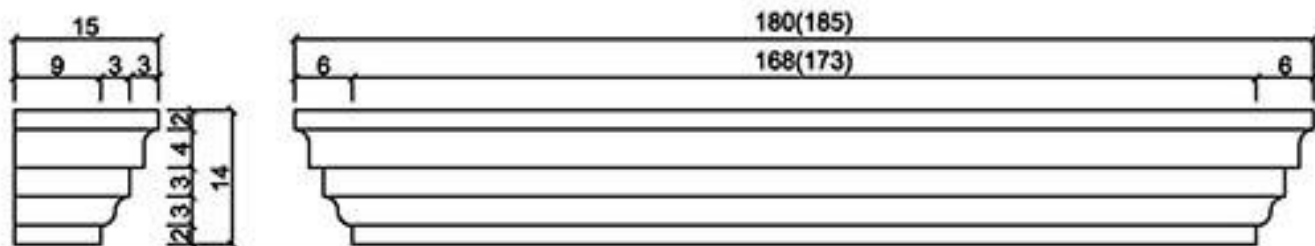

型號 WL-1514-180(185)

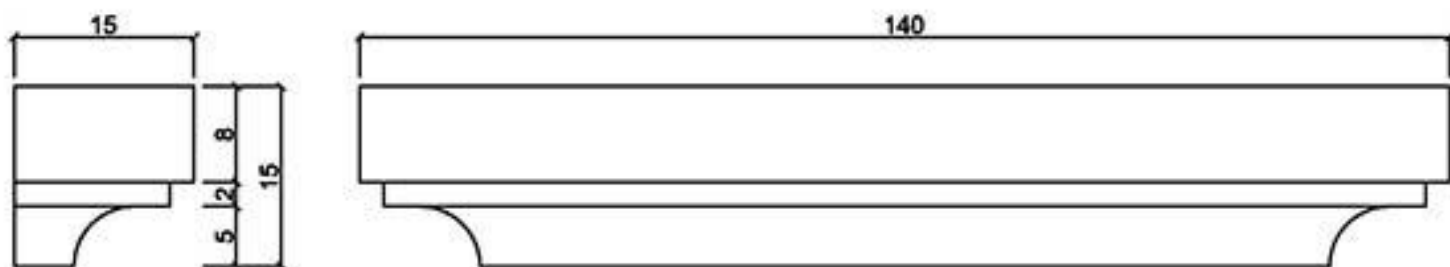

型號 WL-1515-140

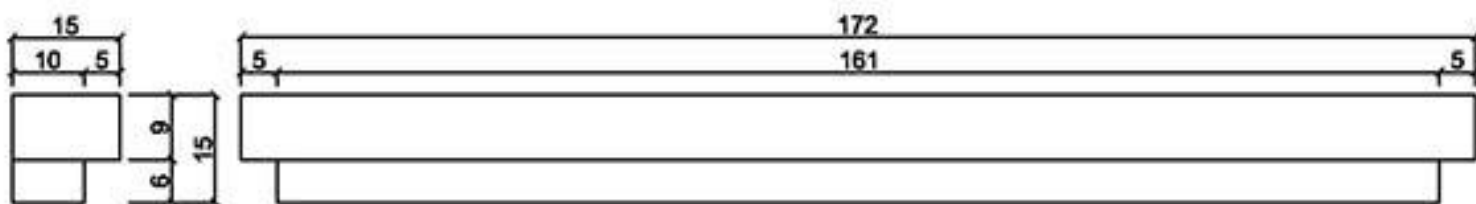

型號 WL-1515A-172

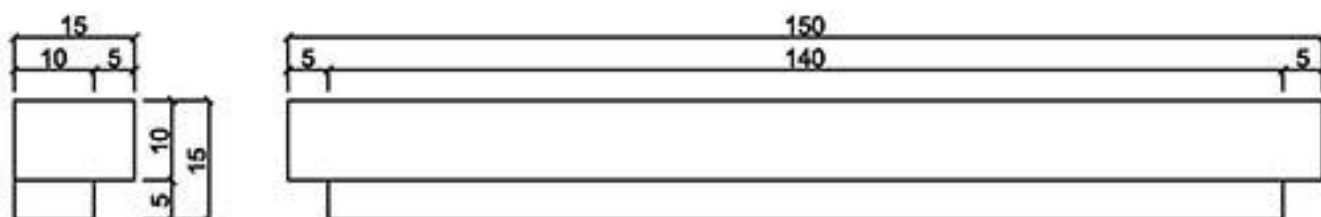

型號 WL-1515D-150

龍潭元勝股份有限公司

WL-7

ASCENT Architectural Material Limited

GRC窗台線版 桃園縣龍潭鄉文化路571號 TEL: (03) 471-3991 FAX: (03) 471-3982

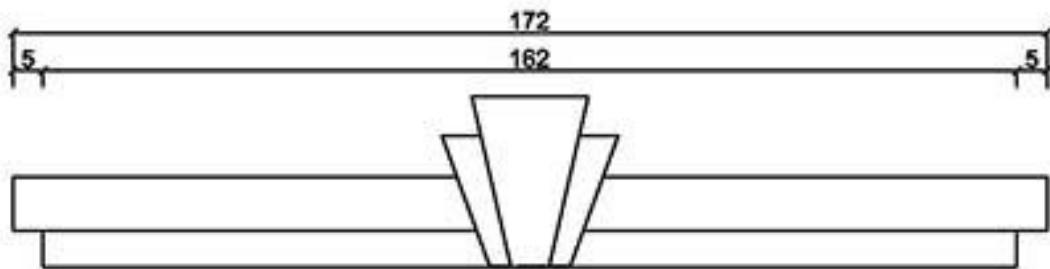
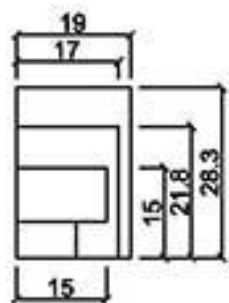

型號

WL-1515S-172

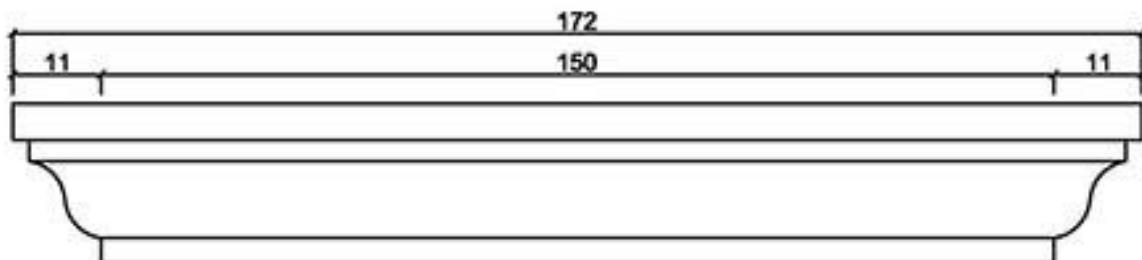
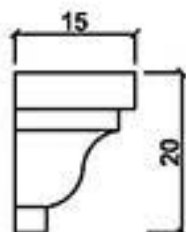

型號

WL-1520A-172

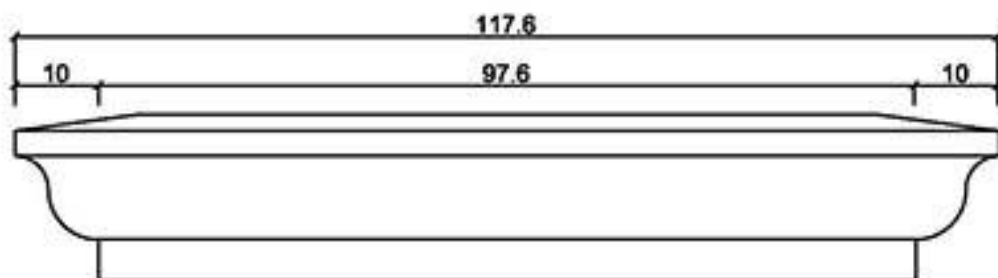
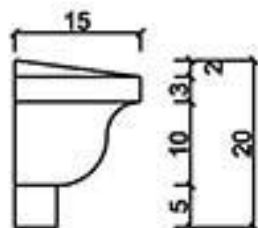

型號

WL-1520B-117.6

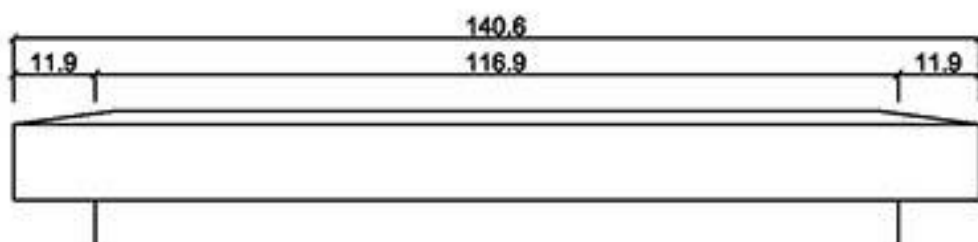
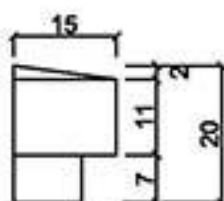

型號

WL-1520C-140.6

龍潭元勝股份有限公司

WL-8

ASCENT Architectural Material Limited

GRC窗台線版 桃園縣龍潭鄉文化路571號 TEL: (03) 471-3991 FAX: (03) 471-3982

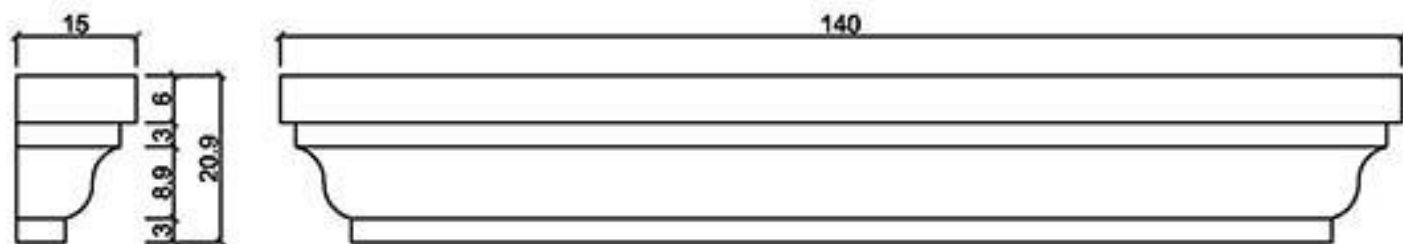

型號

WL-1521-140

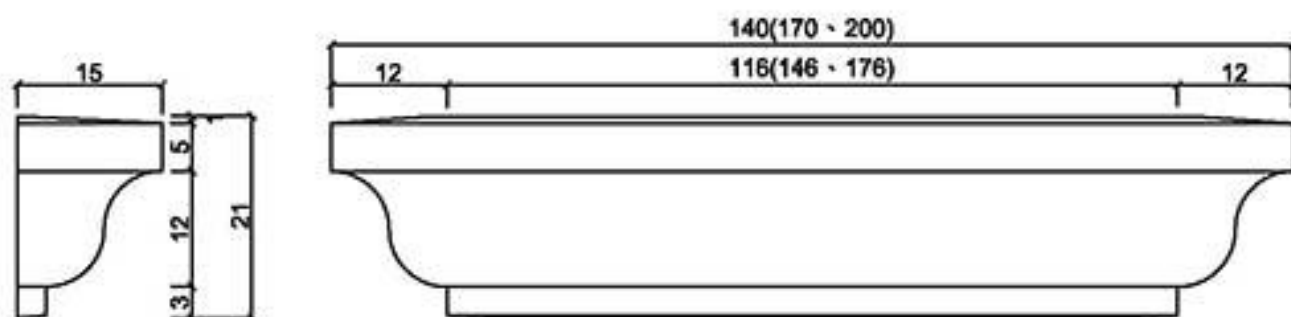

型號

WL-1521S-140(170、200)

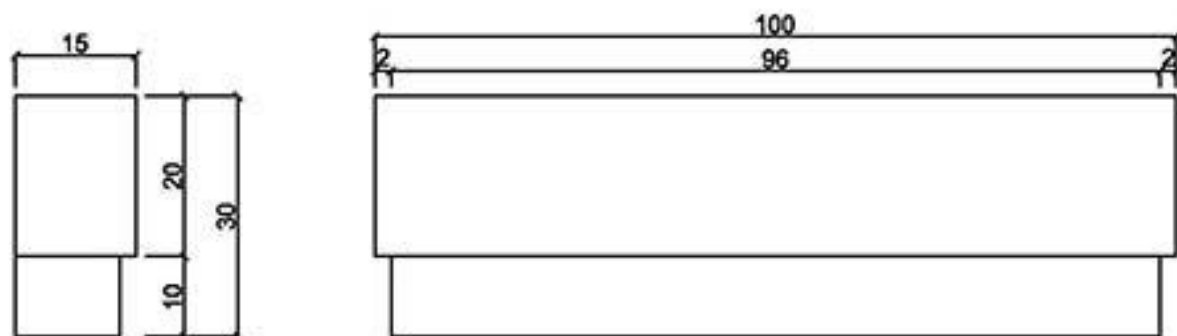

型號

WL-1530D-100

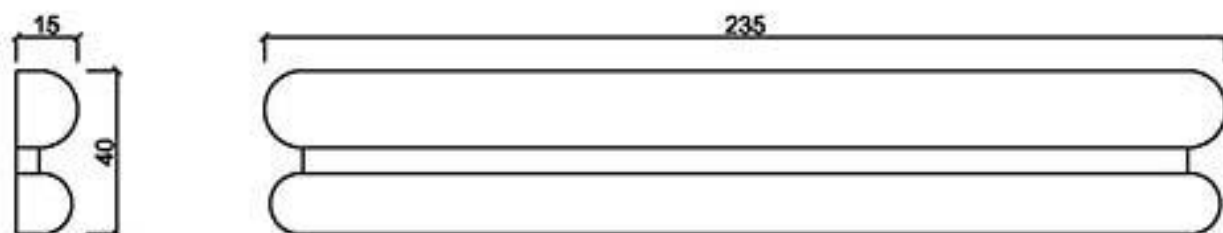

型號

WL-1540-235

龍潭元勝股份有限公司

WL-9

ASCENT Architectural Material Limited

GRC窗台線版 桃園縣龍潭鄉文化路571號 TEL: (03) 471-3991 FAX: (03) 471-3982

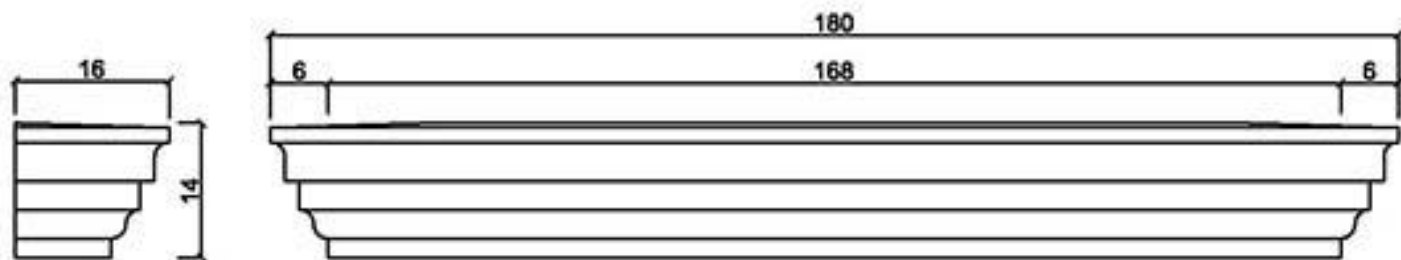

型號

WL-1614-180

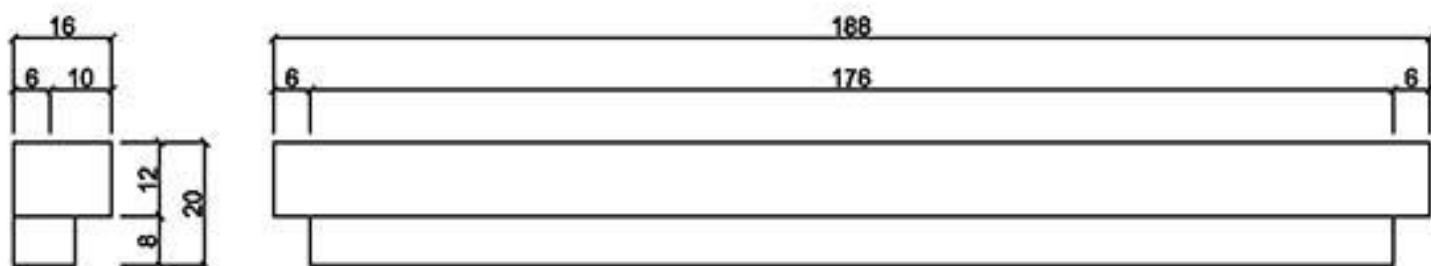

型號

WL-1620-188

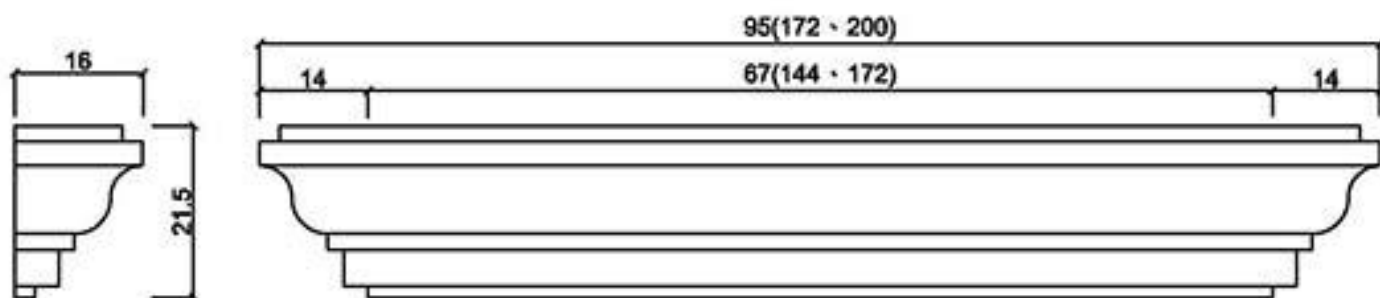

型號

WL-1621-95(172, 200)

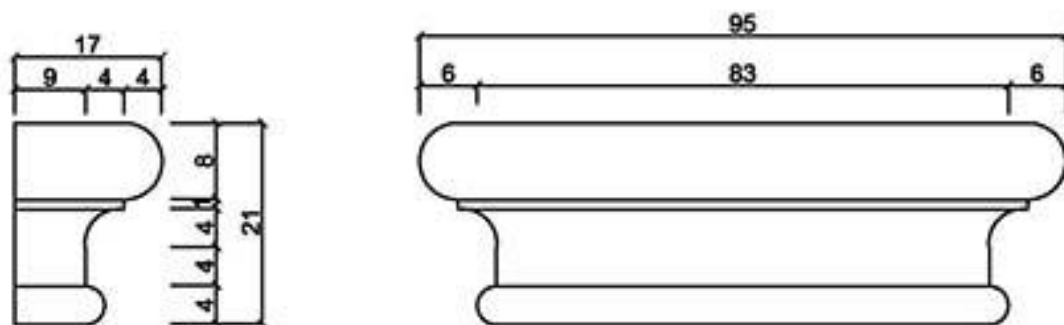

型號

WL-1721C-95

龍潭元勝股份有限公司

WL-10

ASCENT Architectural Material Limited

GRC窗台線版 桃園縣龍潭鄉文化路571號 TEL: (03) 471-3991 FAX: (03) 471-3982

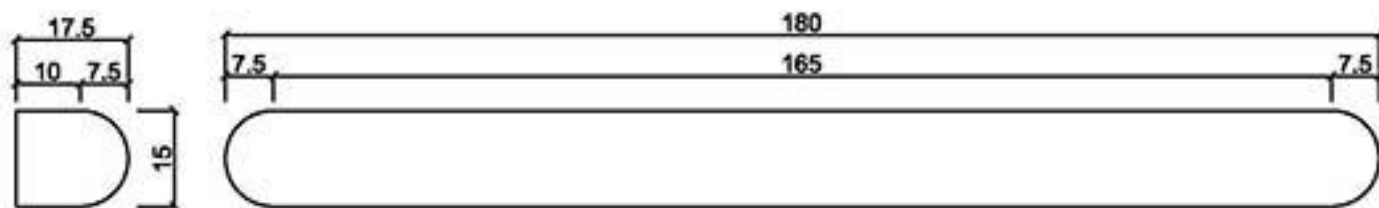

型號

WL-1815-180

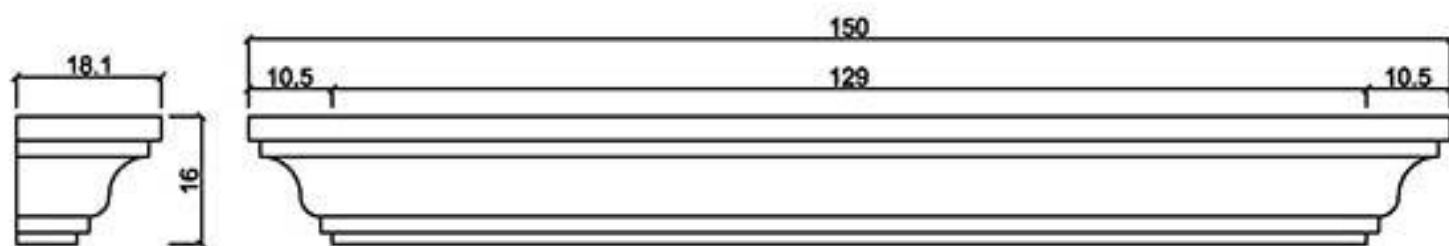

型號

WL-1816-150

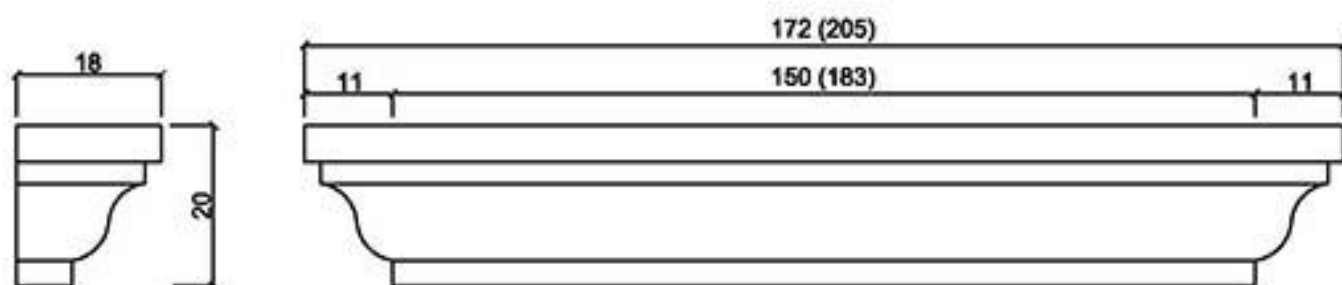

型號

WL-1820-172(205)

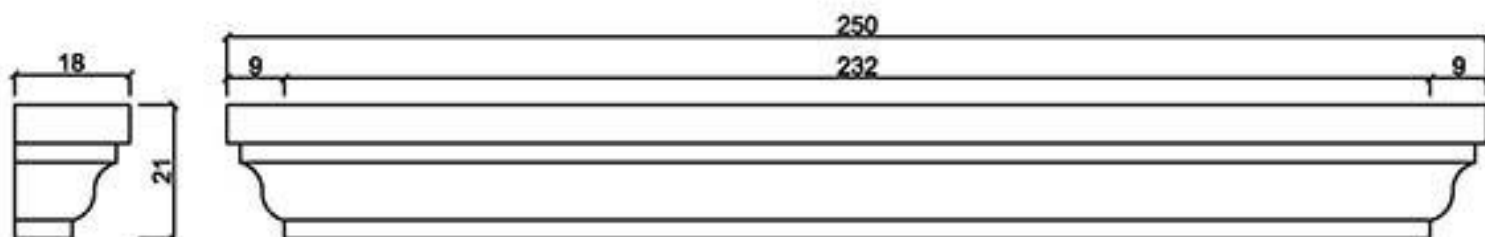

型號

WL-1821-250

龍潭元勝股份有限公司

WL-11

ASCENT Architectural Material Limited

GRC窗台線版 桃園縣龍潭鄉文化路571號 TEL: (03) 471-3991 FAX: (03) 471-3982

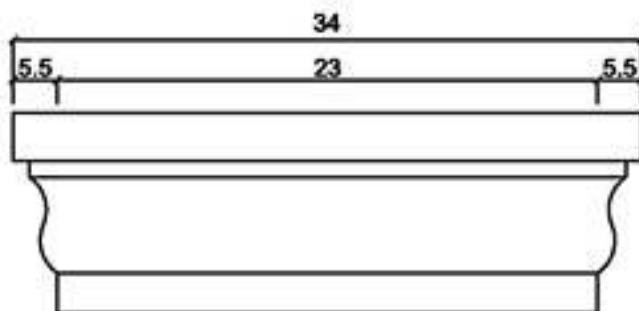
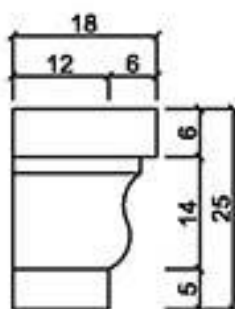

型號

WL-1825-34

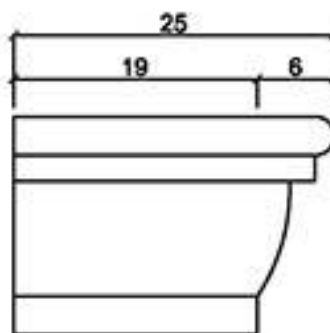
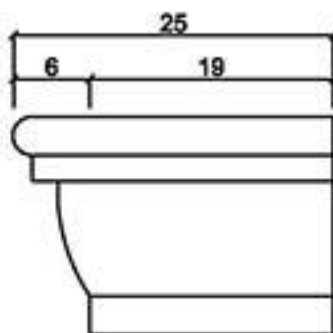
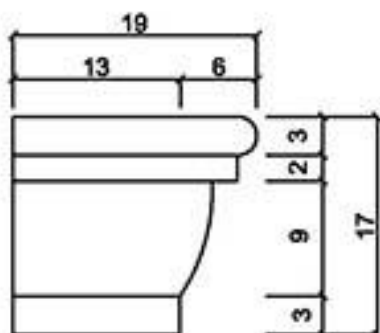

型號

WL-1917-25 R/L

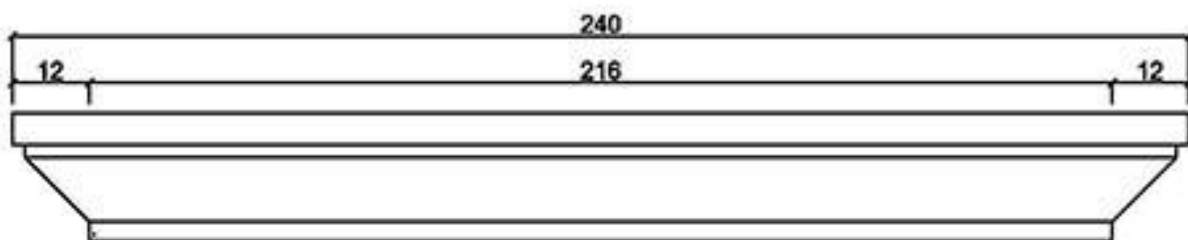
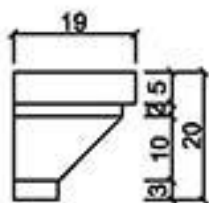

型號

WL-1920-240

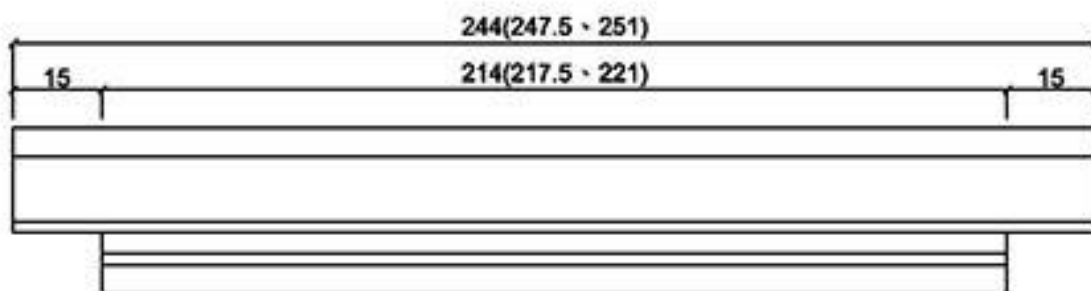
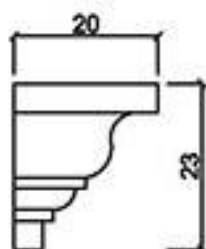

型號

WL-2023 (244、247.5、251)

龍潭元勝股份有限公司

WL-12

ASCENT Architectural Material Limited

GRC窗台線版 桃園縣龍潭鄉文化路571號 TEL: (03) 471-3991 FAX: (03) 471-3982

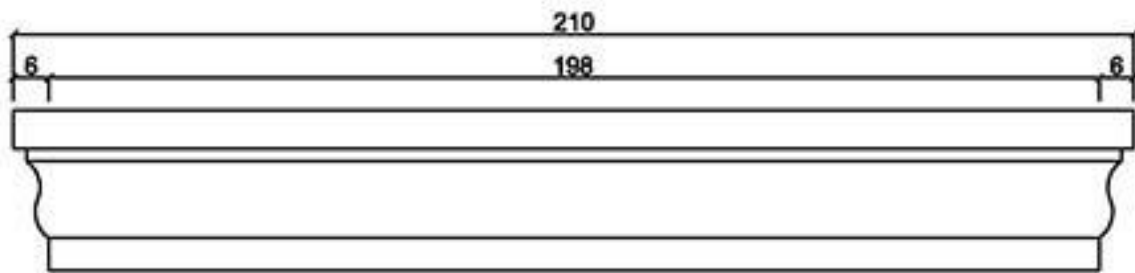
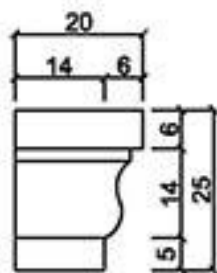

型號

WL-2025-210

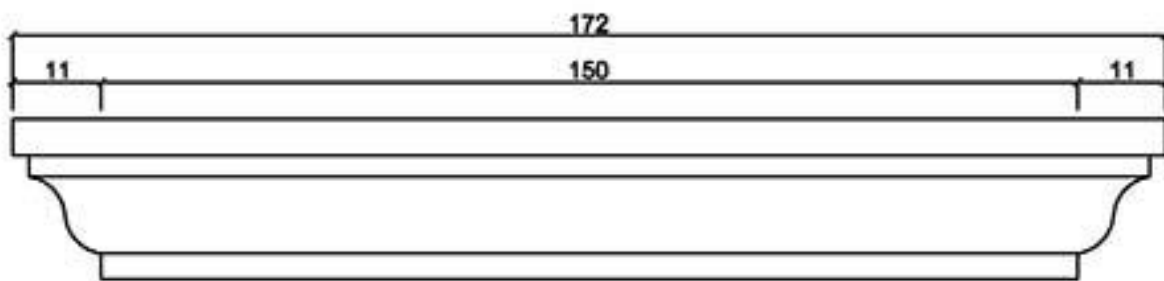
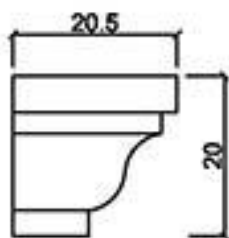

型號

WL-2120-172

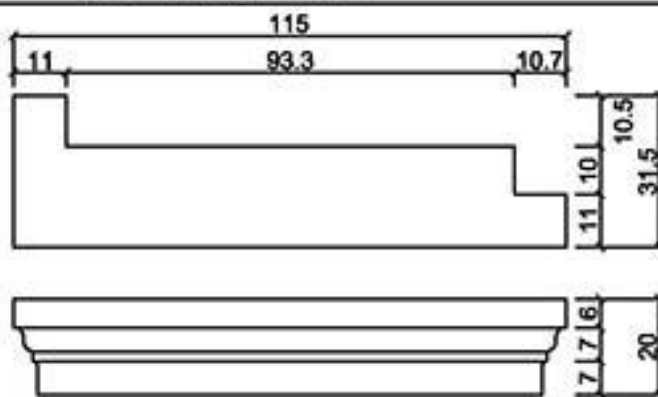
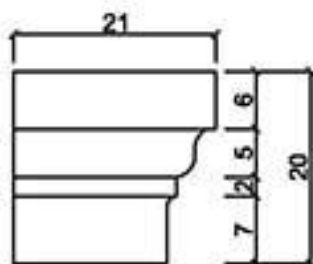

型號

WL-2120S-115

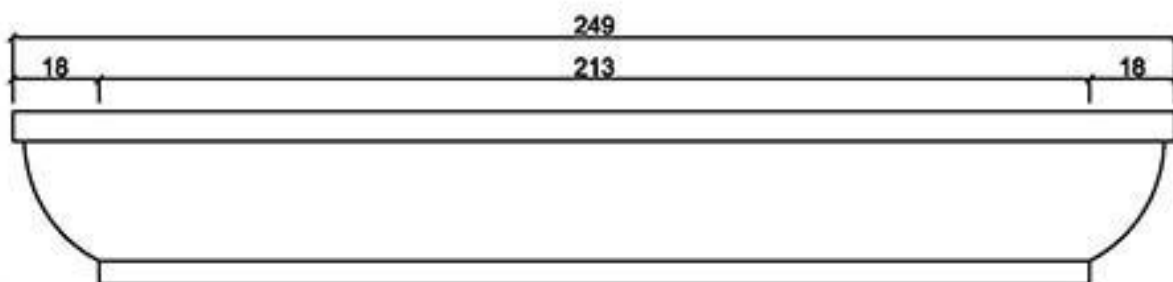
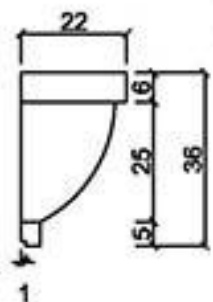

型號

WL-2236N-249

龍潭元勝股份有限公司

WL-13

ASCENT Architectural Material Limited

GRC窗台線版 桃園縣龍潭鄉文化路571號 TEL: (03) 471-3991 FAX: (03) 471-3982

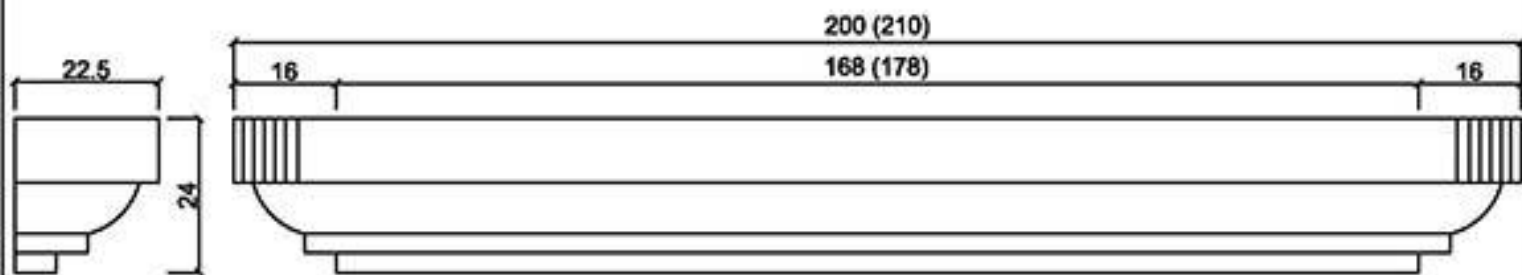

型號

WL-2324-200 (210)

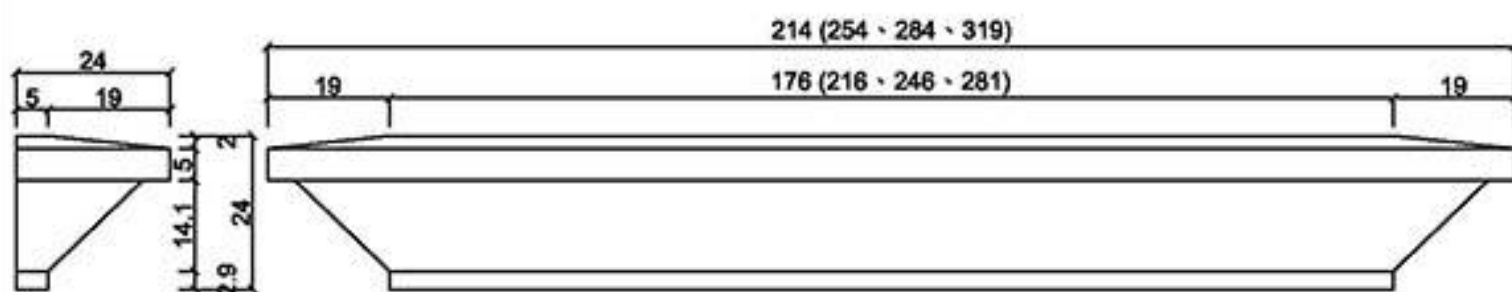

型號

WL-2424-214(254, 284, 319)

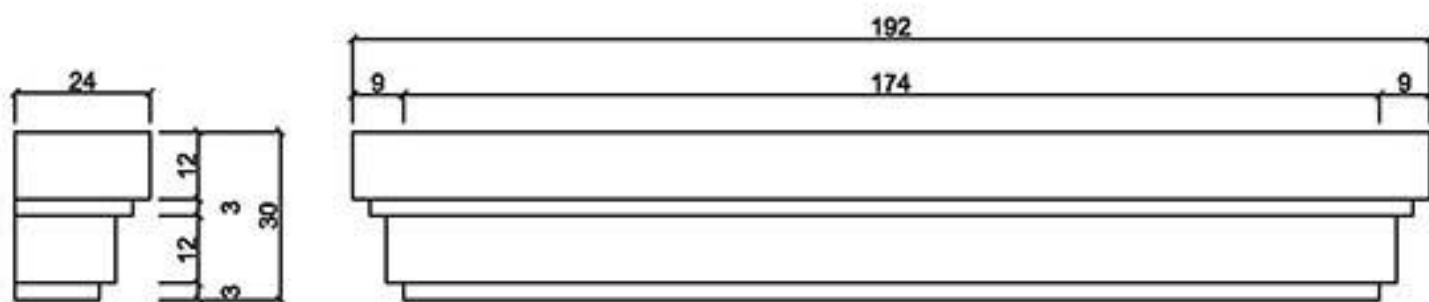

型號

WL-2430-192

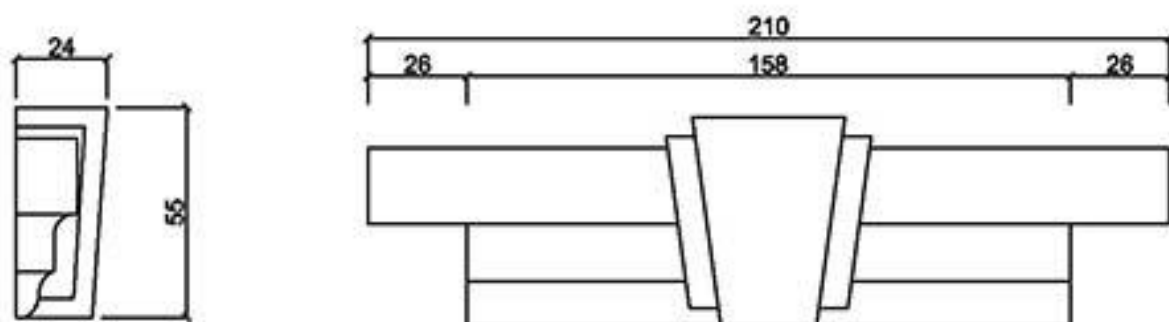

型號

WL-24210-210

龍潭元勝股份有限公司

WL-14

ASCENT Architectural Material Limited

GRC窗台線版 桃園縣龍潭鄉文化路571號 TEL: (03) 471-3991 FAX: (03) 471-3982

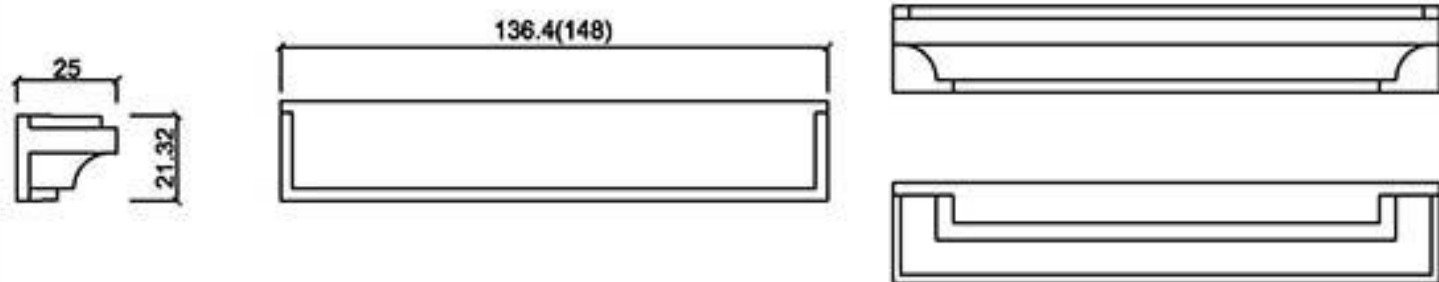

型號

WL-2521-88 (136.4、148、205.1)

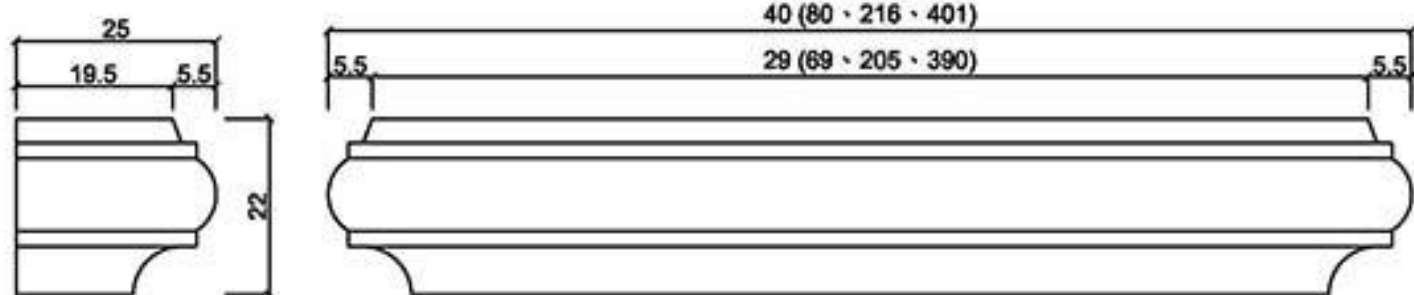

型號

WL-2522-40(80、216、401)

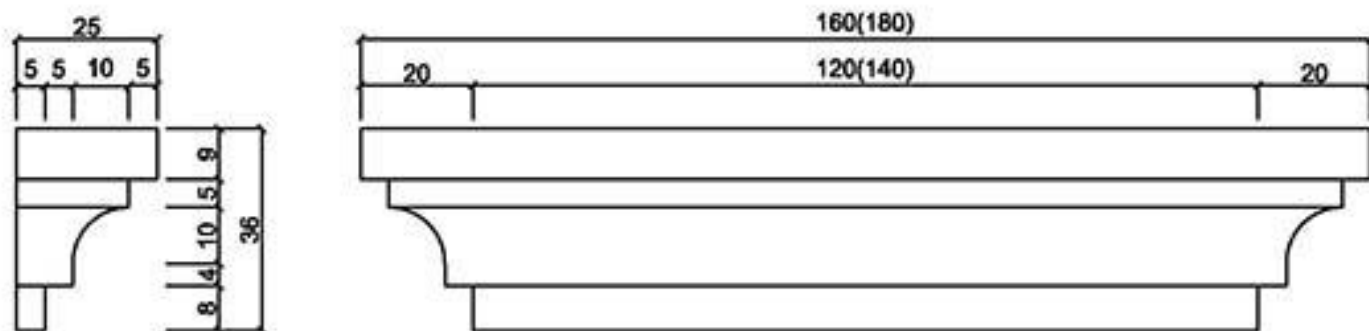

型號

WL-2536-160(180)

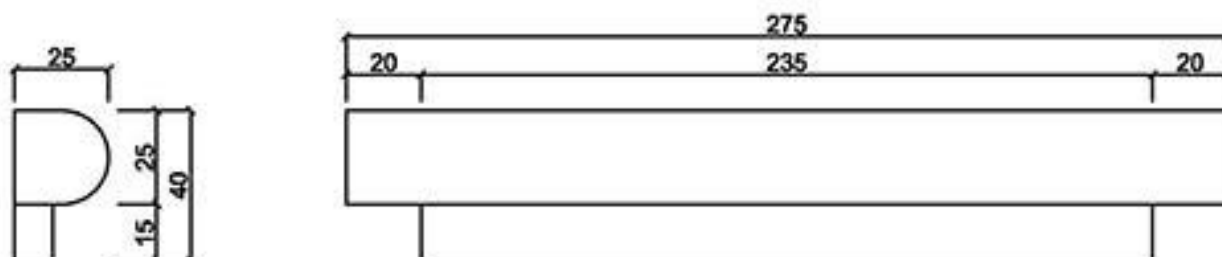

型號

WL-2540-275

龍潭元勝股份有限公司

WL-15

ASCENT Architectural Material Limited

GRC窗台線版 桃園縣龍潭鄉文化路571號 TEL: (03) 471-3991 FAX: (03) 471-3982

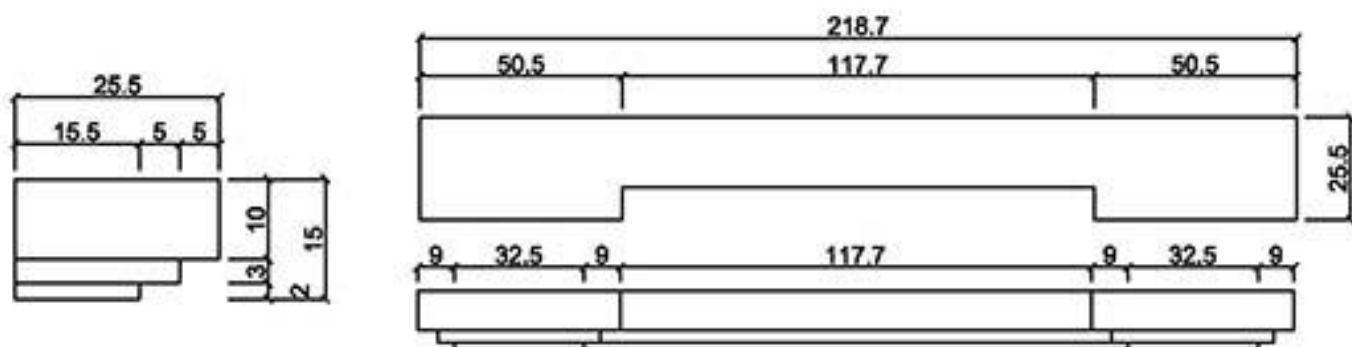

型號

WL-2615-218.7

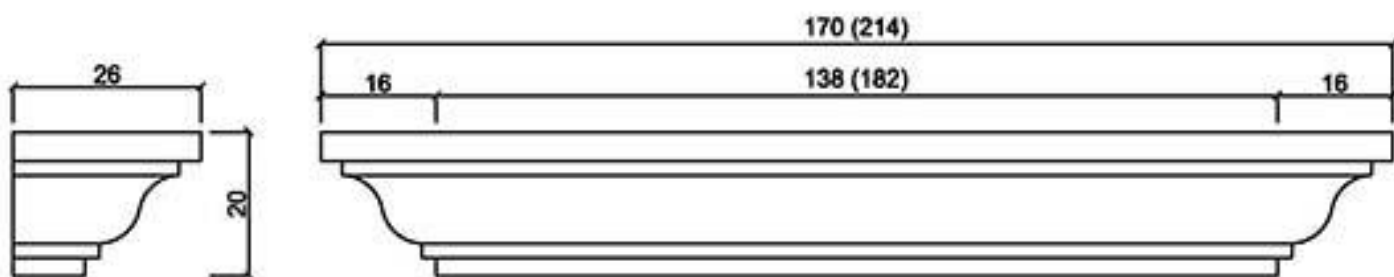

型號

WL-2620-170 (214)

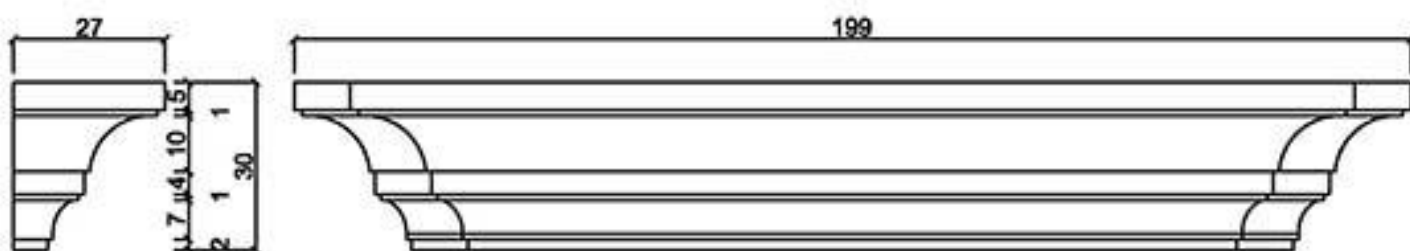

型號

WL-2730

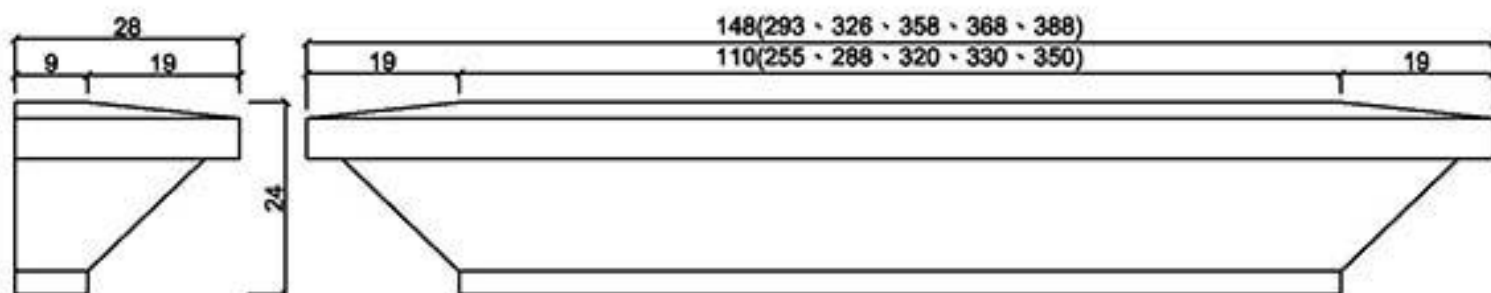

型號

WL-2824-148 (293、326、358、368、388)

龍潭元勝股份有限公司

WL-16

ASCENT Architectural Material Limited

GRC窗台線版 桃園縣龍潭鄉文化路571號 TEL: (03) 471-3991 FAX: (03) 471-3982

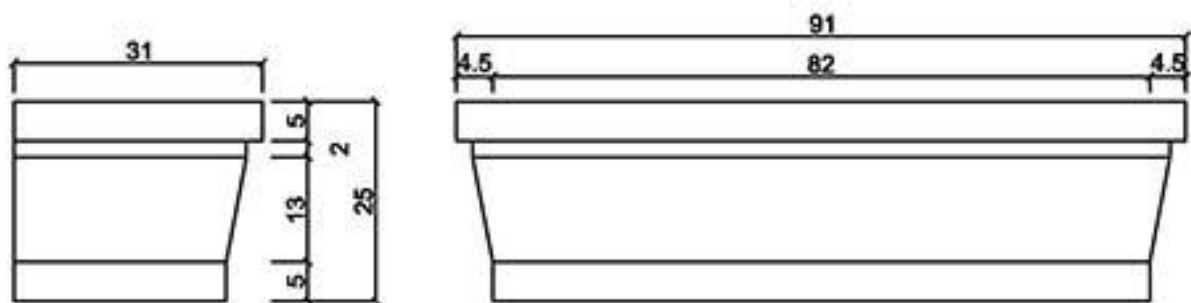

型號

WL-3125-91

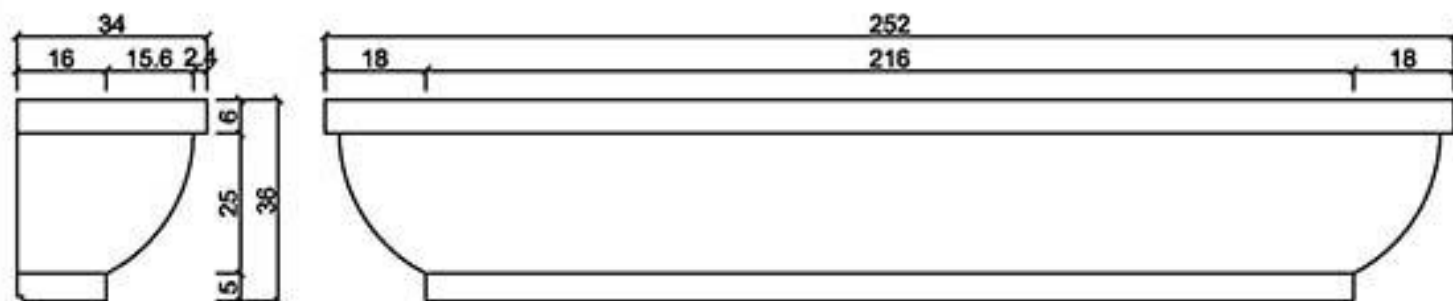

型號

WL-3436N-252

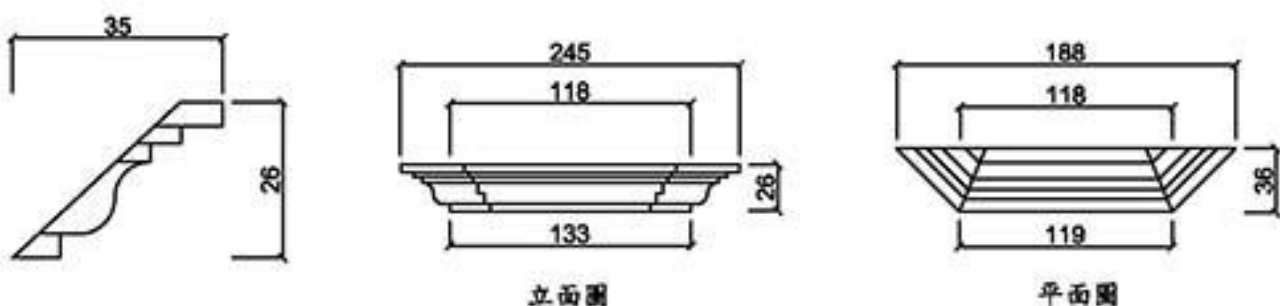

型號

WL-3526N-188(245)

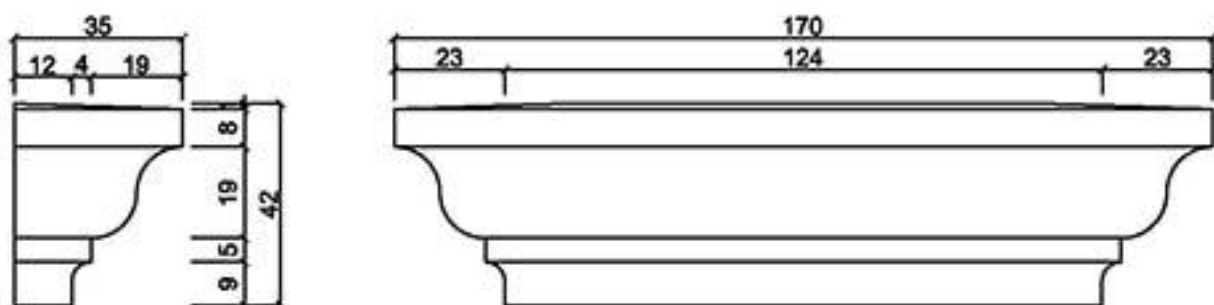

型號

WL-3542A-170

龍潭元勝股份有限公司

WL-17

ASCENT Architectural Material Limited

GRC窗台線版 桃園縣龍潭鄉文化路571號 TEL: (03) 471-3991 FAX: (03) 471-3982

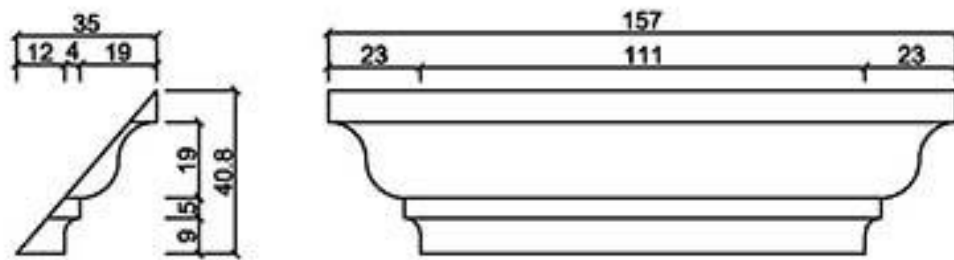

型號

WL-3542AN-157

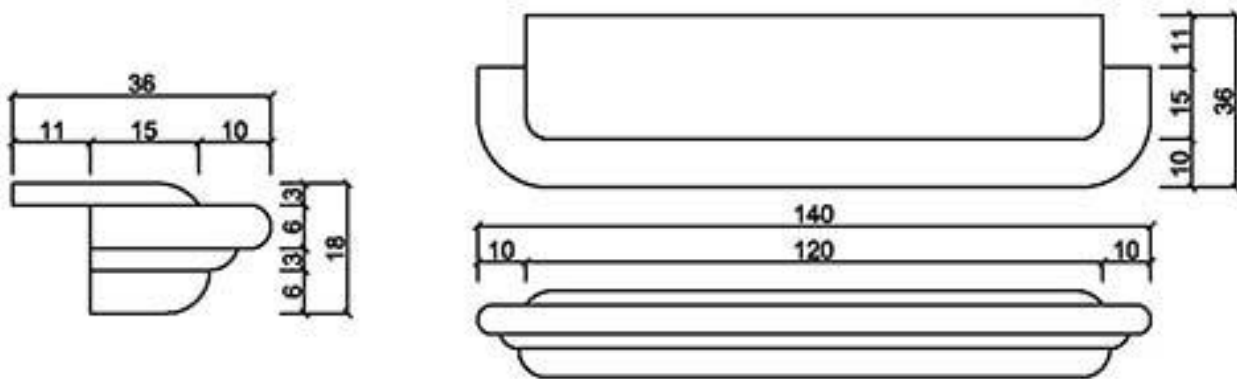

型號

WL-3618-140

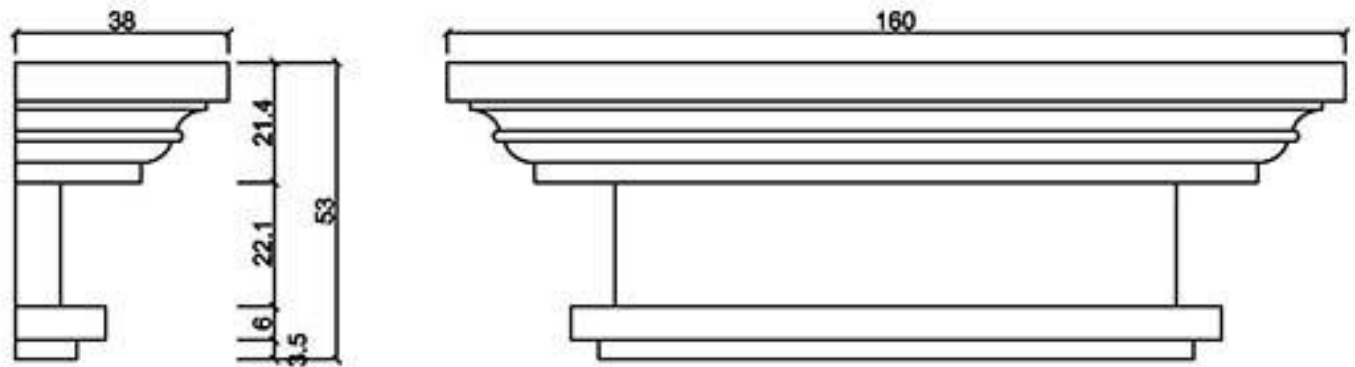

型號

WL-3853N-160

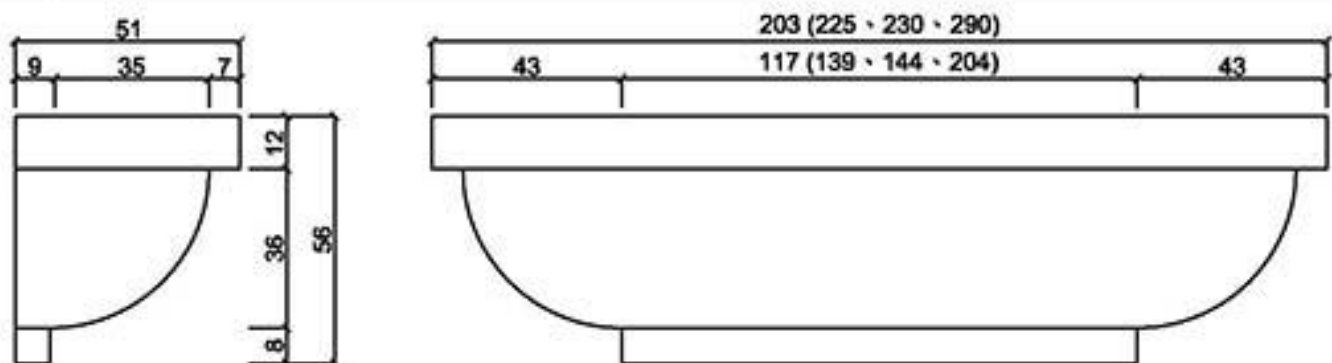

型號

WL-5156N-203 (225、230、290)

龍潭元勝股份有限公司

WL-18

ASCENT Architectural Material Limited

GRC窗台線版 桃園縣龍潭鄉文化路571號 TEL: (03) 471-3991 FAX: (03) 471-3982

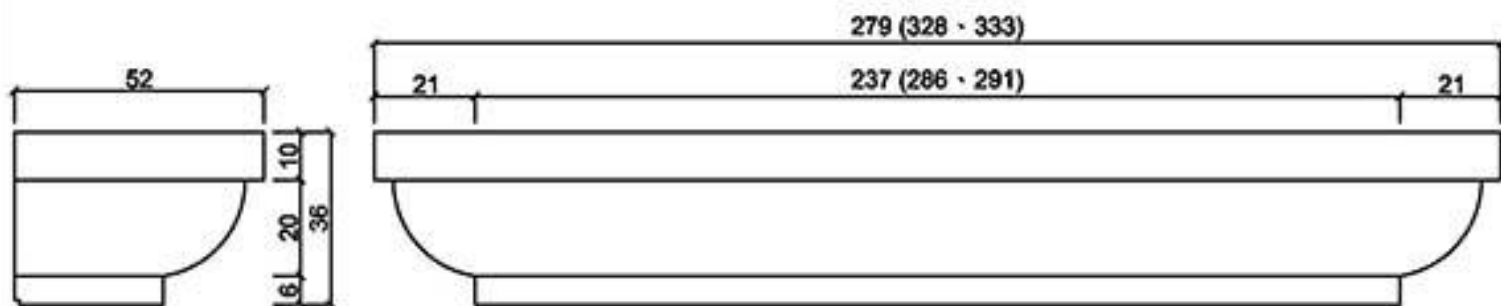

型號 WL-5236AN-279(328、333)

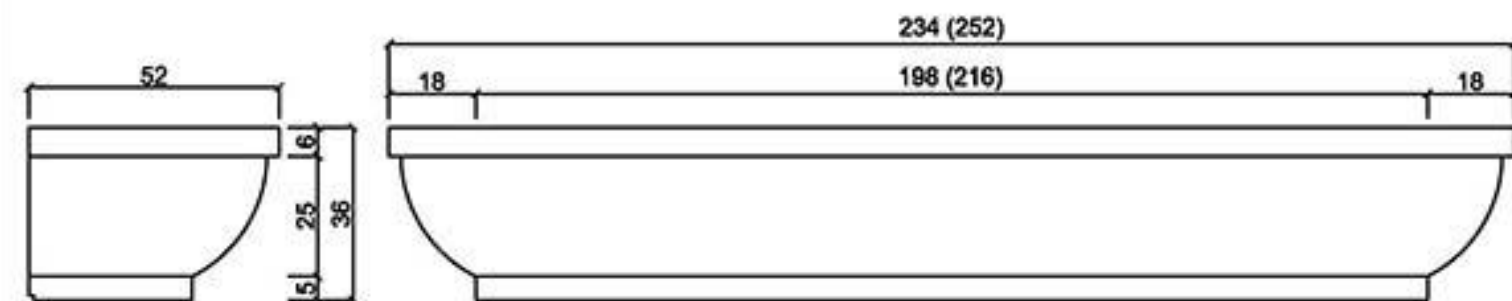

型號 WL-5236N-234(252)

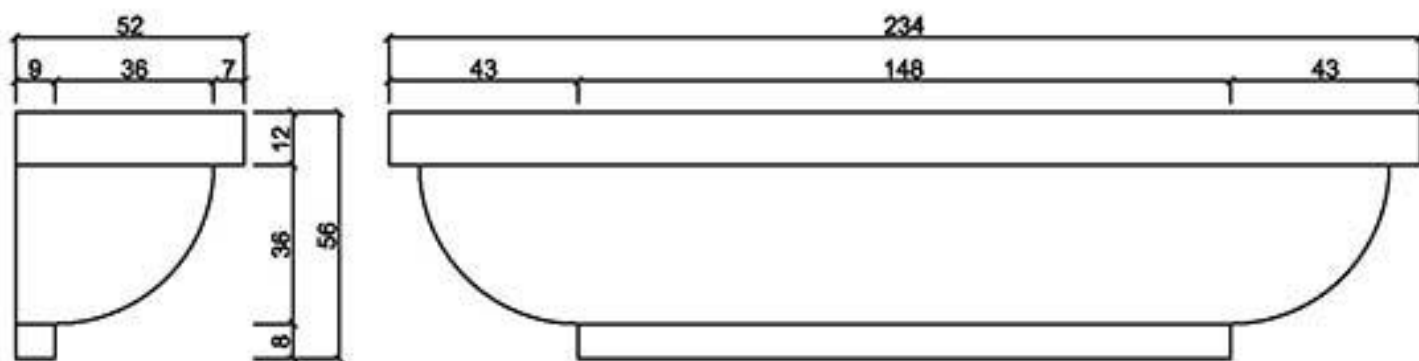

型號 WL-5256N-234

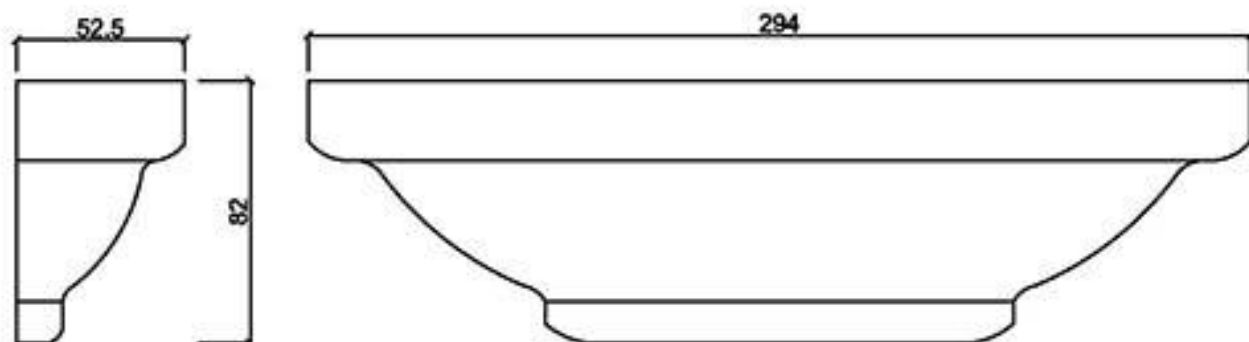

型號 WL-82294

龍潭元勝股份有限公司

WL-19

ASCENT Architectural Material Limited

GRC窗台線版 桃園縣龍潭鄉文化路571號 TEL: (03) 471-3991 FAX: (03) 471-3982

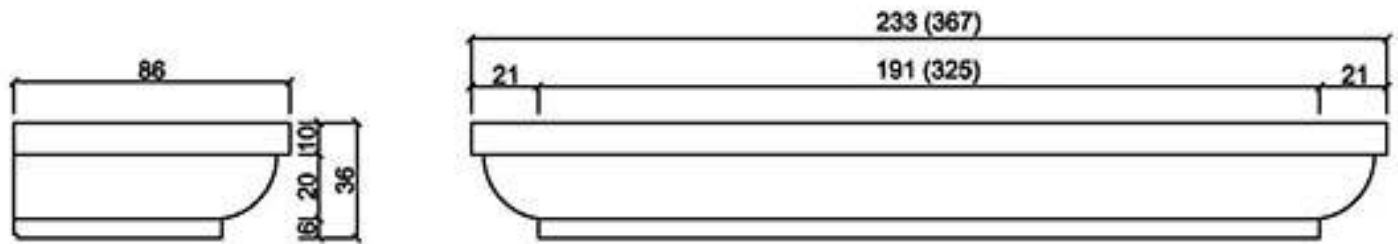

型號

WL-8736N-233(367)

型號

型號

型號